

SEC-VD-DSW Multiple Display Control

Ver. 15.0

2020-11-06

Multiple Display Control Protocol

Copyright © 2004 2020 Samsung Electronics Co., Ltd

Copyright notice

This document is Copyright © Samsung Electronics, Co. – all rights reserved.

Writer : Display S/W, Video Display Division.

Summary : Common protocol specification of MDC(Multiple Display Control)

Revision History :

Customer Document

Version	Date	Contents	Writer	Approver
1.0	2007.04.27	Protocol for Multiple Display Control	SQE	
1.1	2007.06.15	MDC Protocol 추가 및 정리	SQE	
1.2	2007.06.08	MDC Protocol 상세설명 추가	SQE	
1.3	2007.07.06	DIRECTCHANNEL 추가	SQE	
1.4	2007.08.10	RGB Control Ack Data 에 Color Control 추가	SQE	
1.5	2007.09.04	Direct Channel Control (DTV) 추가	SQE	
1.6	2007.11.23	Model Number Control (0x10) 에 Model 추가 (700DXn, 820DXn, 460TXn)	SQE	
1.7	2008.03.03	Model Number Control (0x10) 에 Model 추가 (400Uxn, 460Uxn, 460TXn)	SQE	
1.8	2008.03.20	SCREENMODE (0x18) Command 추가 ASPECTRATIO(0x15) 에 Just Scan 추가 Safety Screen Control(MFM, 0x5B)에 Pixel Shift, Side Gray 추가	SQE	
1.9	2008.10.29	Model Number Control 항목에서 Model 추가	SQE	
2.0	2008.12.30	Model Number Control 항목에 Model 추가 Input Source Control(MFM) 항목의 Inpu 추가 및 명칭 수정 0x20 MagicNet -> 0x20 MagicInfo, 0x21 HDMI -> 0x21 HDMI1, 0x22 HDMI_PC -> 0x22 HDMI1_PC 변경 및 0x23 HDMI2, 0x24 HDMI2_PC 추가.	SQE	
2.1	2009.02.12	Model Number Control 항목의 0x25: SyncMaster 460UT, 0x26: SyncMaster 460Utn 를 0x25: SyncMaster 460Utn-UD, 0x26: SyncMaster 400UT(n) 로 변경	SQE	
2.2	2009.02.20	Model Number Control (0x10) 에 0x27 ~ 0x29 추가함	SQE	
2.3	2009.03.10	Model Number Control 의 0x26: SyncMaster 400UT(n)을 460UT(n)으로 변경	SQE	
2.4	2009.03.16	Model Number Control (0x10) 에 0x2A ~ 0x2D 추가함	SQE	
2.5	2009.03.20	Model Number control(0x10)에 0x2E 추가	SQE	
2.6	2009.03.23	Model Number control(0x10)에 0x2F 추가	SQE	
2.7	2009.04.10	Model Number control(0x10)에 0x30 추가	SQE	
2.8	2009.04.29	Model Number control(0x10)에 0x31 추가	SQE	
2.9	2009.05.12	Model Number control(0x10)에 0x31 수정 Model Number control(0x10)에 0x32 추가	SQE	
3.0	2009.06.30	Model Number control(0x10)에 0x33 추가 Firmware Update Control 추가	SQE	
3.1	2009.07.07	Model Number control(0x10)에 0x34, 0x35 추가	SQE	
3.2	2009.08.24	Model Number control(0x10)에 0x36 추가	SQE	
3.3	2009.09.04	Model Number control(0x10)에 0x37 추가, 0x32 수정	SQE	
3.4	2010.01.15	LFD Protocol, Command 추가	SQE	
3.5	2010.02.11	Model Number control(0x10)에 0x38, 0x39 추가	SQE	
3.6	2010.02.12	LFD Protocol, Command 추가	SQE	
3.7	2010.02.17	Model Number control(0x10)에 0x3A, 0x3B, 0x3C 추가	SQE	
3.8	2010.03.02	Model Number control(0x10)에 0x3D 추가	SQE	
3.9	2010.03.05	Protocol 수정	SQE	

4.0	2010.03.11	LFD Protocol 추가	SQE	
4.1	2010.03.15	LFD Protocol 추가	SQE	
4.2	2010.04.02	Model Number control(0x10)에 0x3E, 0x3F 추가	SQE	
4.3	2010.04.08	Model Number control(0x10)에 0x3F 추가	SQE	
4.4	2010.04.20	Model Number control(0x10)에 0x40 추가	SQE	
4.5	2010.05.26	Model Number control(0x10)에 0x41, 0x42 추가	SQE	
4.6	2010.06.09	Model Number control(0x10)에 0x43 추가, Energy Saving_LFD command 추가	SQE	
4.7	2010.11.12	LFD 과제를 위한 MDC Protocol 문서 수정	SQE	
4.8	2011.06.01	Model Number control(0x10)의 수정 : 0x41 에 SyncMaster 400BX 추가, Model Number control(0x10)의 추가 : 0x44, 0x45 추가	SQE	
4.9	2011.06.08	명령어 List 에 0x65 추가(0x47 과 동일동작)	SQE	
5.0	2011.06.15	MDC_Protocol_Update_List.gul 에 수정내역 기입	SQE	
5.1	2011.06.28	0x17,0x14,08B 변경, 0xFD,0xE0,0xC0 추가	SQE	
5.2	2011.07.01	0xA4,0xA5,0xA6,0xC1 변경,0xFD 추가	SQE	
5.3	2011.07.11	0x00 변경, 0xFE 추가	SQE	
5.4	2011.07.21	Net PIP Data 11 S.Select offset 값 변경(1 / 0 → 0 / 1)	SQE	
5.5	2011.09.30	0xC1 수정	SQE	
5.6	2011.10.12	User Auto Color, Video Picture Position & Size, Reset Control 기능에 대해 항상 NAK 로 변경	SQE	
5.7	2011.12.02	Model Number Control 에 0x44 LFD 모델명 추가	SQE	
5.8	2011.12.05	Picture Mode 에 Calibration Mode 추가	SQE	
5.9	2011.12.06	5.8 Calibration Mode → Calibration 용어 변경	SQE	
6.0	2011.01.30	Volume Up/Down(0x62), Timer4~7(0xAB~0xAE) Command 추가, Input Source 의 MagicInfo Lite 를 Media 로 용어 변경, Input Source 에 OPS 추가(0x50)	SQE	
6.1	2012.03.05	MDC EditName Command 추가	SQE	
6.2	2012.03.22	Model Number control(0x10)의 추가 : 0x46 추가	SQE	
6.3	2012.04.04	Model Number control(0x10)의 추가 : 0x47 추가	SQE	
6.4	2012.04.17	Input Source(0x14) 프로토콜내 source 추가	SQE	
6.5	2012.04.19	- 0x59,0x5B Command 의 Safety Screen Control 기능에 Rolling Bar, Fading Screen 추가 - 0x63 Command Ticker 기능 추가 - OPS Source 용어 Plug In Module 로 변경 - 0x44, 0x46 Command 모델 추가(ME32B, ME65B, ME75B, DE40B) 및 모델명 변경(DE40C, DE46C, DE55C)	SQE	
6.6	2012.04.23	Model Number control(0x10)의 추가 : 0x48 추가	SQE	
6.7	2012.04.26	Maintenance Control(0x08) Data Length 0x15, 0x19 의 두 가지 Mode 로 분리	SQE	
6.8	2012.04.27	Ticker(0x63) Command 에 Foreground Color 0x00 과 0x01 순서 변경	SQE	
6.9	2012.05.07	Pc Module Detect Command 추가(0x66)	SQE	
7.0	2012.05.08	Pc Module Detect Command 삭제(0x33)	SQE	
7.1	2012.05.31	- Device Name(0x67) 추가 - Set Picture Size 의 PC1, PC2, DVI, BNC,HDMI_PC 에 original ratio 목록 추가	SQE	
7.2	2012.06.14	p20 의 RGB Control (PC, BNC, DVI Only) 프로토콜 Ack	SQE	

		부분 순서 수정(오기 수정)		
7.3	2012.06.17	Model Number Control 의 Device 모델명 표 수정 (31p.)	SQE	
7.4	2012.07.26	Speaker Select Command 추가 (0x68)	SQE	
7.5	2012.08.16	Peripheral Chip Control 추가 (0xE1)	SDQ	
7.6	2012.09.25	White Balance Factory Reset 추가 (0xF2)	SDQ	
7.7	2012.10.19	Virtual Remote Control Command 추가(0xB0)	SDQ	
7.8	2012.11.23	LFD Display Port Daisy Chain Command 추가 PIP Size Control 사양 변경(LFD)	SDQ	
7.9	2012.12.10	LFD MDC Command(Edit Name Control) 추가 → DVD Receiver, HD STB, DVD Combo, DHR	SDQ	
8.0	2012.12.26	모델 Number 에 0x4A (ED32C/ED40C/ED46C/ED55C/ED65C/ED75C/H32C/H40C/H46C/H55C) 추가	SDQ	
8.1	2012.12.27	Model Number Control (0x10) 커맨드에 Value 추가 (0x49)	SDQ	
8.2	2013.01.14	Model Number 추가 - Model Number 신규 추가(0x4B, 0x4C, 0x4D) - Model Number 에 모델 추가(0x46 에 UDC, UEC 모델 추가)	SDQ	
8.3	2013.01.28	Set Digital Picture Position&Size Length 값 변경(1→2)	SDQ	
8.4	2013.02.13	p.194 : NET PIP Command 중 Channel Number 에 해당하는 Data 15~19 Byte 가 일정 값일 때 Channel 정보를 보지 않고 Last Memory Channel 로 PIP On 하도록 함	SDQ	
8.5	2013.02.22	MDC Protocol 사용하는 홍콩공항에서 OSD Display On/Off Command 를 반대로 사용하는 것을 명시함	SDQ	
8.6	2013.03.05	고객사 홍콩공항에서 사용하는 MDC Protocol 에 대한 예외 상황 추가(p.121), 기존내용 삭제(p.173)	SDQ	
8.7	2013.03.05	SW Version Control(0x0E) Command Data Length 및 설명 변경	SDQ	
8.8	2013.03.07	SW Version Control(0x0E) Command Data Length 및 설명 변경(100 → 52)	SDQ	
8.9	2013.03.14	Safety Screen Control(MFM/LFD) (0x5B) 설명 추가 “(Type 이 Rolling Bar 이거나 Fading Screen 일 때는 T.Time 이 0 이라도 Off 되지 않는다.)”	SDQ	
9.0	2013.04.11	MDC Protocol Command 추가 0xB2: 3Screen/4Screen Mode Control, 0xB3: Video Conference Sound Mode Control, 0xB4: Screen Mute Control	SQE	
9.1	2013.05.29	Model Number Control 0x49 에 Model name 추가 : ME95C	SQE	
9.2	2013.06.07	Input Source Control (MFM)에 0x61 WiDi 추가	SQE	
9.3	2013.06.13	3Screen/4Screen Mode Control (0xB2) 설명에 제약사항 추가	SQE	
9.4	2013.06.24	User Gamma Control(0xC2) 추가	SQE	
9.5	2013.06.24	Model Number Control 의 0x4E 항목에 모델 신규 추가 : SyncMaster UD55C-B	SQE	
9.6	2013.08.07	Supported Function Control in LFD (0xC4) 추가	SQE	
9.7	2013.08.16	Apply Calibrated data for All Source or Current Source(0xC3) 추가	SQE	
9.8	2013.08.20	Clock Control(Sec 단위 정보 추가) - 186p.	SQE	
9.9	2013.09.03	“P.Mode Control”의 MFM/LFD 계열 Source 에 0x04 Natural, 0x05 Calibration 추가	SQE	
10.0	2013.11.13	(0x41) IC Vender, IC Name 변경	SQE	
10.1	2013.11.15	Model Number Control 0x10 command 의 값 0x4F 에 모델 추가	SQE	

10.2	2013.11.21	P.Mode Control 의 P.Mode 추가 Color Temperature Control 의 C.Temp 조정간격 세분화 Gamma Control Mode 추가 MagicInfo Remote Controller Key 타입 추가 Reset Control 의 Reset Module 추가	SQE	
10.3	2013.12.11	Remote Control(0x36) 문구 추가 (LFD 제품의 경우 DPMS 상황에서는 설정 값과 관계없이 Remocon 이 동작한다.)	SQE	
10.4	2014.01.02	Model Number control(0x10)에 0x50 추가	SQE	
10.5	2014.01.16	Network Standby Control, DST Control 추가	SQE	
10.6	2014.01.16	MagicInfo Remote Controller 내에 Pause key 값(0x4A) 추가	SQE	
10.7	2014.02.04	Model Number Control 에 모델 추가(0x51-RB32D, RB40D, RB48D), 0x4A(ED32D/ED40D/ED46D/ED55D/ED65D/ED75D)	SQE	
10.8	2014.02.07	MagicInfo Remote Controller[0xc1] cmd 중복내용 삭제	SQE	
10.9	2014.02.10	MagicInfo Remote Controller_key 추가(FF_SKIP, REW_SKIP), Color Temperature Control 의 3200K Param 추가	SQE	
11.0	2014.02.10	White balance MDC Control 의 RDB 모델 RGB Gain/offset 값의 Range 와 Default 값 추가	SQE	
11.1	2014.02.11	Serial Number Control 범위 15Byte 로 증가	SQE	
11.2	2014.02.12	Network Standby Control, DST Control, Custom PIP Control, Auto ID Setting Status Control Command 추가, PIP Size Control Custom(0x10) 추가	SQE	
11.3	2014.02.17	Display ID Information Advanced IDG control, Control ACM mode 추가	SQE	
11.4	2014.02.18	0x10 Model Number Control 에 0x51 항목에 2 개모델 추가 (RM40D/RM48D)	SQE	
11.5	2014.02.19	DST Ack 에 Tuner/Tunerless Data 추가, Display ID Information CMD 0xC5 -> 0xB9 로 수정.	SQE	
11.6	2014.03.13	Ticker Foreground Opacity 에서 0x04, 0x05 추가, White Balance MDC Control, WB Type1 추가, Supported Function Control in LFD, ACM12, Gamma Correction 0x02 추가, Custom PIP Control, The PIP Start Position and Size do not over panel H, V size 관련 note 추가	SQE	
11.7	2014.03.20	Apply To Control 추가, DHD 추가 On Timer 의 source 중 0x62 : Internal/USB 추가	SQE	
11.8	2014.03.28	MGA Gamma Data Control 추가	SQE	
11.9	2014.04.01	UHD Scaler LFD 모델 코드 추가	SQE	
12.0	2014.04.30	0xC4 명령중 UHD Scaler 내용 추가, 문서 command 순서대로 재정리	SQE	
12.1	2014.05.10	Model Number Control 에 DM65D/DM75D 추가, White Balance MDC Control 0x51 cmd 의 11~14 삭제	SQE	
12.2	2014.06.11	DisplayPort 2, 3 source 추가(0x26, 0x27), Model Number Control QMD 모델명 수정	SQE	
12.3	2014.07.03	Input Source Control (MFM) 0x62,0x63 추가, EcoSolution control in MDC Protocol Data 변경, Control Launcher by MDC Protocol, Set Launcher - Overall 에 부연 문구 추가	SQE	
12.4	2014.07.15	3screen 의 DataLength, 4screen 의 Val1 수정	SQE	
12.5	2014.07.25	r-CMD 0x10 의 Val 2 의 0x50(OM64D/OM55D/OM75D) 추가	SQE	
12.6	2014.08.26	White Balance MDC Control 0xFE command 에 pattern 추가	SQE	
12.7	2014.08.29	Control ACM mode Control type 에 WB 추가	SQE	
12.8	2014.10.08	1. Command Table 수정	SQE	

		<ul style="list-style-type: none"> - 지원함으로 변경 : 0x4b, 0x75, 0x9c, 0x9d - 지원안함으로 변경 : 0x01, 0x03, 0x4f, 0x74, 0x81, 0x88, 0x8c, 0x8d, 0x8e, 0x90, 0x91, 0x93 - 0xc8, OnScreen Display control command 추가 <p>2. 0x8b, Video Wall Direct User Control</p> <ul style="list-style-type: none"> - Table 값 15x15 기준으로 수정 - Input source table 을 삭제하고 0x14 input command 의 table 을 참조하도록 명기함 - Wall_Div table 을 삭제하고 0x89, Video Wall User Control command 의 table 을 참조하도록 명기함 - Wall_Sno table 을 삭제하고 0x89, Video Wall User Control command 의 table 을 참조하도록 명기함 <p>3. 0x3f, Color Temperature Control</p> <ul style="list-style-type: none"> - table hex value 추가 <p>4. 0x63, Ticker</p> <ul style="list-style-type: none"> - ticker msg max 25 자로 수정(Menu 동일사양) <p>5. 0xc8, OnScreen Display control command 추가</p>		
12.9	2014.11.19	<p>1. Command Table 수정</p> <ul style="list-style-type: none"> - 지원함/지원하지 않음 내용 삭제(별도 table 관리) - Data Type 세부 정리 <p>2. Smart Signage 에서 사용하지 않는 Command 삭제</p> <ul style="list-style-type: none"> : 제품팀 검토결과 사용하지 않는 Cmd - 0x0a, 0x1f, 0x20, 0x21, 0x22, 0x23, 0x35, 0x39, 0x3a, 0x3b, 0x46, 0x49 0x82, 0x98, 0x99, 0x9a, 0x9b : 정채불명(table 에는 있으나 세부 command 설명 없음) - 0x0c, 0x1a, 0x1b 0x1c, 0x5e, 0x60, 0x7b, 0x7c, 0x7d, 0xdd, <p>2. 0x14, Input Source Control (MFM)</p> <ul style="list-style-type: none"> - WiDi -> WiDi/Screen Mirroring <p>3. 0x85, Temperature Control</p> <ul style="list-style-type: none"> - Input range is changed as 75~124 <p>4. 0x5B, Screen Burn Timer</p> <ul style="list-style-type: none"> - T.Time 값 10~50 sec 으로 수정 및 code table 추가 <p>5. 0x87, Dynamic Contrast</p> <ul style="list-style-type: none"> - Limitation 변경 → 모든 Source 에서 동작하며 특정 Picture Mode 에서만 동작함 <p>6. 0x18, Screen Mode Control</p> <ul style="list-style-type: none"> - Limitation 변경 → It will work on Video Wall Off, Landscape or Picture size is Auto Wide. (Picture Size Auto Wide is only used on European Tuner Signal) 	SQE	
13.0	2014.12.18	<p>1. 0x14, Input Source Control</p> <ul style="list-style-type: none"> - 설명추가 : 0x60 → Media/MagicInfo S - Source 추가 : 0x64 - IWB(Get only), 0x55 - HDBaseT <p>2. 문서 전 영역에서 AM : 1 / PM : 0 으로 표기하여 혼선을 없앴</p> <p>3. 0xc8, OnScreen Display control</p> <ul style="list-style-type: none"> - Orientation option 변경 : Landscape(0), Portrait(270), 180, 90 - 0x84, NetPIP Rotation subcommand 추가 <p>4. 0x15, Picture Size Control</p> <ul style="list-style-type: none"> - 신규 mode - 21:9 및 note 추가 <p>5. 0x10, Model Number Control</p> <ul style="list-style-type: none"> - NT 계열 모델 정리 - GolfS 계열 모델 추가 - QMD105 모델 추가 <p>6. 0x83, Panel On time</p>	SQE	

		<ul style="list-style-type: none"> - 설명추가 : 10 분당 1 count 증가 <p>7. 0x20, Model Number Control</p> <ul style="list-style-type: none"> - Panel type 추가 		
13.1	2015.02.03	<p>1. 0xc8, Onscreen Display control</p> <ul style="list-style-type: none"> - 0x84, PIP Rotation : 제약사항 Note 추가 <p>2. 0x10, Model Number Control</p> <ul style="list-style-type: none"> - 모델 추가 0x55 : RH48E, RH55E - 모델 추가 0x4f : OH46D, OH55D <p>3. 0xb6, DST Control</p> <ul style="list-style-type: none"> - DST 설정시 Month range 수정 : 00 ~ 0C -> 00 ~ 0b <p>4. 0xb7, Custom PIP Control</p> <ul style="list-style-type: none"> - 설정범위 오류 수정 : Note : The PIP Start Position and Size do not over panel H, V size H/V Size : 512 * 288 ~ 1632 * 918 (Interval : 160 pixel) 512*288, 672*378, 832*468, 992*558, 1152*648, 1312*738, 1472*828, 1632*918 <p>5. 0x2e, Balance Control</p> <ul style="list-style-type: none"> - GolfS 에서 변경된 사양 Note 로 추가 <p>6. 신규 cmd 추가</p> <ul style="list-style-type: none"> - 0x1a, Outdoor mode control - 0x8c, Video Wall Feature control - 0xba, Upgrade Control <p>7. 0xc4, Supported Function Control</p> <ul style="list-style-type: none"> - Add a new format for adding FWUpdate protocol status 	SPD	
13.2	2015.03.05	<p>1. Overallly, remove the description of TV product</p> <p>2. Change the spec of 0x8c, Video Wall Feature control.</p> <ul style="list-style-type: none"> - Sub command 0x83, Frame Delay is changed (Delay time is removed) <p>3. Table data error fix - 0x3f, Color TemperatureTable</p> <ul style="list-style-type: none"> - 14500K : 145(0x92) -> 150(0x91) - 15000K : 150(0x97) -> 150(0x96) <p>4. Change the NAK format of 0x8c, 0x1a.</p> <p>5. Add new command</p> <ul style="list-style-type: none"> - 0x0A, Signage Player Control - 0x8c Sub command : 0x90 Show Videowall position - 0x8c Sub command : 0xA0 Irregular videowall position - 0xD0 LED Product Feature <p>6. Add Annex A, to describe about RTV command</p>	SPD	
13.3	2015.05.08	<p>1. 0x10, Model Number Control</p> <ul style="list-style-type: none"> - Add UDE model code <p>2. 0x0a, SignagePlayer Control</p> <ul style="list-style-type: none"> - 0x81, ChildStatus : add model code information <p>3. 0xc4, supported Function</p> <ul style="list-style-type: none"> - Platform 에 option 추가 : 0x11 Novatek SE15HV <p>4. Add an index</p> <p>5. Command table</p> <ul style="list-style-type: none"> - Add sub command description - Remove No and variable name 	SPD	

		<p>6. 0x10 Model Number control</p> <ul style="list-style-type: none"> - 0x57 - IL015E/ IL025E are added - 0x58 - signage box <p>7. 0xc4 Supported function control</p> <ul style="list-style-type: none"> - Platform - 0x12 : NT14F is added <p>8. 0xD0 LED Product Feature</p> <ul style="list-style-type: none"> - Detail data is changed <p>9. PIC_MODE for MDC command is defined and added to related command</p> <ul style="list-style-type: none"> - Definition : AnnexB - Applied Command : 0x04, 0x06, 0x24, 0x25, 0x26, 0x27, 0x28, 0x37, 0x38, 0x3E, 0x3F, 0x4B, 0x73, 0x75, 0x9d <p>10. Add a command 0x1B. Network Configuration</p> <ul style="list-style-type: none"> - Sub 0x81, MAC Address(Get only) <p>11. 0x94, HDMI Black Level Control</p> <ul style="list-style-type: none"> - Option 0x02-Auto 추가 		
13.4	2015.05.23	<p>1. 2.1.10 Model Number Control 에 모델 추가</p> <ul style="list-style-type: none"> - DM65E-BR, DM75E-BR, DM82E-BR / Samsung / Golf-S / - - UD46E-P, UD55E-P, UD55E-S / Samsung / Golf-S / ACM 	SPD	
13.5	2015.07.28	<p>1. 0x95, Black Adjust Control Control</p> <ul style="list-style-type: none"> - Add working condition detail <p>2. 0x73, Digital NR Control</p> <ul style="list-style-type: none"> - Add Note in Working Condition <p>3. 0xD0, LED Product Feature</p> <ul style="list-style-type: none"> - Sub 0x82 Input Source Info : Add Media Source - Sub 0x82 Input Source Info : Ack length fix to 0a - Sub 0x83 Get Product Information : Ack length fix to 08 - Add Sub 0x85 Get/Set ABL Mode - Add Sub 0x90.Cabinet FW data, 0x91.Cabinet Calibrated Data - Add Sub 0x92. Module HB(RGB) Control <p>4. 0x8c Videowall Feature Control</p> <ul style="list-style-type: none"> - 0xa0, Irregular videowall control videowall rotation 관련 내용 수정 <p>5. Description error fix</p> <ul style="list-style-type: none"> - 0x08, Maintenance Control : Makes it clear P.Size is for PIP Size - 0x07, PIP Status Control : Makes it refer 0x42 cmd for P.Size <p>6. 0x83 Panel On time</p> <ul style="list-style-type: none"> - Modify the ack length as 4 <p>7. 0x08 Maintenance Control</p> <ul style="list-style-type: none"> - Add a note for videowall unsupported case <p>8. 0xe3 Control ACM mode</p> <ul style="list-style-type: none"> - New options are added <p>9. 0x11.Power Command</p> <ul style="list-style-type: none"> - Add a reboot option <p>10. Add 0xC9.Sound Menu Control</p> <ul style="list-style-type: none"> - Sub cmd 0x81.HDMI Sound <p>11. 0x1B.System Configuration</p> <ul style="list-style-type: none"> - Add sub cmd 0x91.UART Speed <p>12. Add 0x1C.MagicInfo Control</p>		

		<ul style="list-style-type: none"> - Sub cmd 0x81.MagicInfo Channel 13. Add 0xCA.System Menu Control - Sub cmd 0x81.Auto Source Switch On/Off 		
13.6	2015.12.02	<ol style="list-style-type: none"> 1. 0x1C MagicInfo Control <ul style="list-style-type: none"> - Ch no date length extend as 2bytes 2. 0xCA System Menu Control <ul style="list-style-type: none"> - Add sub command 0x82 Auto Source switch control 3. Add 0x1F Still Control 4. 0xD0-LED Product <ul style="list-style-type: none"> - 0x92. Module WB (RGB) Control is modified - 0x93. Cabinet WB (RGB) Control is added 5. 0x4B Video Picture Position & Size <ul style="list-style-type: none"> - Direction 관련 설명오류 수정 6. 0x3F Color Temperature Control <ul style="list-style-type: none"> - Working condition 수정 7. 0x10 Model code 추가 <ul style="list-style-type: none"> - 0x59, 0x5a, 0x5b 8. 0xCA System Menu Control <ul style="list-style-type: none"> - Add Sub command 0x91. Power Button - Add Sub command 0xa1. No Signal Power Off 9. Working condition is changed for 10allowed command <ul style="list-style-type: none"> 0x04, 0x06, 0x24, 0x25, 0x26 0x27, 0x28, 0x37, 0x38, 0x3e, 0x75 		
13.7	2016.02.23	<ol style="list-style-type: none"> 1. 0x1b System Control <ul style="list-style-type: none"> - Add 0xa1 FANet Contro control 2. 0x10 Model Number Control <ul style="list-style-type: none"> - Add model code of 0x5c, 0x5d 3. 0xD0 LED Product Feature <ul style="list-style-type: none"> - Add sub command 0xa0, 0xa1, 0xb0, 0xb1 - Delete sub command 90, 91 4. 0x1B System Configuration <ul style="list-style-type: none"> - Add sub command 0x92 - Add sub command 0x82 - Add sub command 0x83 - Add sub command 0x71 5. 0x20 Test Function <ul style="list-style-type: none"> - Add sub command 0x81 7. 0x14 Input Source Control <ul style="list-style-type: none"> - Add HDMI4 8. 0xD7 Test Function <ul style="list-style-type: none"> - Add 0x81 Screen capture 9. 0xA3 OSD Display Type <ul style="list-style-type: none"> - Add option 0x04 Schedule Channel Info 10. Change as Common command from internal <ul style="list-style-type: none"> - 0xc5, 0xca 11. 0xD1 Large Size Data Feature <ul style="list-style-type: none"> - Add sub command 90, 91 		

13.8c		<ol style="list-style-type: none"> 1. Several detail description is fixed(ikes terms) 2. 0x58 Manual Lamp control <ul style="list-style-type: none"> - note is changed. 3. 0x10 Model Number Control <ul style="list-style-type: none"> - model code add - addproduct to model code 0x54 4. 0x15 Picture Size <ul style="list-style-type: none"> - Add PC mode scustom option - Not changed based on model number control 5. 0x14. Input Source Control <ul style="list-style-type: none"> - add Web Browser source : 0x65 		
13.9c		<ol style="list-style-type: none"> 1. 0x10 Model Number Control <ul style="list-style-type: none"> - model code add -Add model code on 0x61,0x62 -Model Code error fix from the code 0x54 2. Picture Size <ul style="list-style-type: none"> -Add new model code 0x60,0x61,0x62 in table 		
14.0c	2017.1.6	<ol style="list-style-type: none"> 1. Change range of TV or Monitor ID <ul style="list-style-type: none"> - change TV or monitor ID range to 225 2. 0x10 Model Number Control <ul style="list-style-type: none"> -model code add (0x5F , 0x63, 0x64) 3. Add Annex B.2 ~B.3 <ul style="list-style-type: none"> - HKIA option specific description add 		
14.1c	2017.04.10	<ol style="list-style-type: none"> 1. 0x10 Model Number Control <ul style="list-style-type: none"> - model code add(0x65 , 0x66 and 0x57) 2. 0x14 Input Source Control <ul style="list-style-type: none"> - add OCM 3. 0x72 Sound mdoe <ul style="list-style-type: none"> - Add 0x06, Optimized mode 4. 0x3E Color Tone detail option change 5. 0x63 Ticker <ul style="list-style-type: none"> - Foreground / Background opacity option description change 6. 0xCA System Menu <ul style="list-style-type: none"> - Add 0x92 Touch Control Admin Lock 9. 0x63 Ticker <ul style="list-style-type: none"> - Foreground / Background opacity option description change 10. 0xCA System Menu <ul style="list-style-type: none"> - Add 0x92 Touch Control Admin Lock 		
14.2c	2017.07.06	<ol style="list-style-type: none"> 1. 0x0D Display Status <ul style="list-style-type: none"> - Add fan error status option 2. 0x10 Model Number <ul style="list-style-type: none"> - Add more model on code 0x56 - Add more model on code 0x5E 3. 0x1C MagicInfo Control <ul style="list-style-type: none"> - Add 0x82 MagicInfo Server Settings - Add 0x83 MagicInfo Content Orientation 4. 0x1D MDC connnection type <ul style="list-style-type: none"> - Add set functionality 		

		<p>5. 0x71 Picturemode Control – Add new picture mode</p> <p>6. 0xc6 Eco Solution – Add 0x82 : Brightness Limit</p> <p>7. 0xC8 Addition of subcommand – 0x85 Menu Size</p> <p>8. 0xC9 Addition of following commands –0x82 Equalizer 200Hz –0x83 Equalizer 500Hz –0x84 Equalizer 2kHz –0x85 Equalizer 5kHz</p> <p>9. New Command – 0x1b, 0x21, 0xb2, 0xC9, 0xD0, 0xFE</p>		
14.3c	2017.12.13	<p>1. 0x10 Model Number – New model is added to 0x68</p> <p>2. 0x1C MagicInfo Control – Sub 0x83 nak format is changed</p> <p>3. 0x21 Picture Control – Sub 0x08, 0x09 are added</p> <p>4. 0x56 Energy_Saving is added</p> <p>5. 0x63 detailed description is changed</p> <p>6. 0xA3 Display Type On/Off – Wrong description is corrected(the description of 14.0 and previous version is correct one)</p> <p>7. 0xCA System Menu control – Add sub 0xB0</p> <p>8. 0xD0 LED Product feature – sub 0x97 add reset field – add sub command 0x87</p>		
14.4c	2018.05.08	<p>1. 0x10 Model Number control – Add new model to 0x69</p> <p>2. 0x14 Input Source – Add source option – Remote Workspace</p> <p>3. 0x1F Still Control – Move to common section</p> <p>4. 0x21 Picture Control – add sub 0x50 Color enhancement – add sub 0x51 Dynamic Backlight – Add sub 0x52 Fit To Screen</p> <p>5. 0xD0 LED Product Feature – On the sub cmd 0x81 : Cabinet type is added – On the sub cmd 0x83 : more option is added – Sub 9A Data Reload is extended as reload multiple type data</p>		
14.5c	2019.02.21	<p>1. 0x0F Auto Motion Plus – Add option</p> <p>2. 0x21 Picture Control – Add sub 0x0a HDR – Dynamic Range Extension</p>		

		<ul style="list-style-type: none"> - Add sub 0x54 Gamma Mode 3. 0x50 Sensor Control <ul style="list-style-type: none"> - Add Sub 0x00 Light Sensor 4. 0x71 Picture Mode <ul style="list-style-type: none"> - Option is added 5. 0x9D Color Space <ul style="list-style-type: none"> - Option is added 6. 0xCA System Menu Control <ul style="list-style-type: none"> - Add Sub 0x83 Power On Delay - Add Sub 0x84 Synced Power On - Add Sub 0x85 Synced Power Off 7. 0xD0 LED Product Feature <ul style="list-style-type: none"> - 0x81 Device type option add - 0x9B Command change - 0x9F Edge Info data change 		
14.6c	2019.03.08	<ol style="list-style-type: none"> 1. 0x09 Sound Control <ul style="list-style-type: none"> - Add a note for not supported item 2. 0x10 Model Number Control <ul style="list-style-type: none"> - Add model code, 0x6b, 0x6c 3. 0x1B System Configuration <ul style="list-style-type: none"> - 0x85 Network IP mode is moved to common 4. 0x21 Picture Control <ul style="list-style-type: none"> - Add sub 0x0B Screen Position - Add sub 0x0C HDR – MultiLink HDR - Add sub 0x53 Uniformity 5. 0x3E, 75 Color Tone <ul style="list-style-type: none"> - Add option for Natural 6. 0xD0, LED Product Feature <ul style="list-style-type: none"> - Sub 0x84, Module data code is additionally defined for 12module support - Sub 0x96 : Add new gamut option 7. 0xFE White Balance <ul style="list-style-type: none"> - Add sub 0x62 White Balance Mode 		
14.7c	2019.07.25	<ol style="list-style-type: none"> 1. 0x00 Status control <ul style="list-style-type: none"> - Add a note for no audio model. 2. 0x08 Maintenance control <ul style="list-style-type: none"> - Add note for invalid P.Source data - Change the note of screen type 3. 0x10 Model Number <ul style="list-style-type: none"> - New model code 0x6d, 0x6E, 0x6F are added 4. 0x1B System Configuration <ul style="list-style-type: none"> - Add sub 0x8A Network Access Point Configuration 5. 0x1C MagicInfo Control <ul style="list-style-type: none"> - Add sub 0x81 MagicInfo Channel 6. 0x21 Picture Control <ul style="list-style-type: none"> - Sub 0x51 Dynamic Backlight, add a note and control option to commonly use it dynmic backlight and dLocal Dimming - Sub 0x54 Gamma Mode : mode “S Curve” is added - Sub 0x55 Black Equalizer is added 	-	

		<p>7. 0x63 Ticker – Change description of Position Vertical data</p> <p>8. C6 Eco Solution Control – 0x81 Auto Power Off : option is added for 16 hours</p> <p>9. 0xD0 LED Product Feature – Sub 0x81, 0x83 : Add more option – Sub 0x9F Multiple Edge Offset Control : add new format command</p>		
14.8c	2020.02.11	<p>1. 0x10 Model Number Control – Models are added to 0x69, 0x6A, 0x70 – QET is added to 0x69</p> <p>2. 0x1A Outdoor – Sub 0x81 Outdoor Mode is added</p> <p>3. 0x1B System Configutarion – Move sub 0x A2 Weekly Restart to common</p> <p>4. 0x21 Picture Control – Add Sub 0x56 HDR+</p> <p>5. B2 3Screen/4Screen Mode Control – Add type3 for picture size not use model</p> <p>6. 0xCA System Menu Control – Add sub 0x93 DICOM Mode</p> <p>7. 0xD0 LED Product Features – Add sub A2 Block Gradation Control – Add sub A3 Block Gradation on/off</p>		
14.9c	2020.06.18	<p>1. MDC ID range is extended to 0~253 – On 0xFD Auto ID Setting MDC Control Command and 1.1. Connection Method</p> <p>2. 0x1A Outdoor – Add sub cmd 0x82 Internal HeatEx Fan Speed Control</p> <p>3. 0x50 Sensor Control – Add sub cmd 01 HeatEx Temperature – Add sub cmd 02 LED Plate Temperature – Add sub cmd 03 Final Duty</p> <p>4. 0x8F Fan Control – Add fan control option</p> <p>5. 0xB0 Virtual Remote Control – Add key code 0x30</p> <p>6. 0xCA System Menu Control – Add sub cmd 0x70 CEC On/Off</p> <p>7. 0xD0 LED Product Features – Sub 0x81,0x83 add option for WALL2.0 – Add sub cmd 0x43 Cabinet Early Warning Data – System – Add sub cmd 0x60 BroadCast Communication Device – Sub 0x81,0x83 add option for WALL2.0 – Sub 0xC4 Data Transfer Request add CRC related data</p> <p>10. 0xD2.40 Cabinet Layout Info – Add new module type</p> <p>11. 0xD2.42 Get Cabinet Initial Connection Info – Dynamic – Ptch, Resolution, PhySize, Aspect Ratio, Modules data format change</p>		
15.0c	2020.11.06	<p>1. 0x10 Model Number Control – Add more model on 0x6E : VMT-U, VHT-E, VMT-E – Add new model code of 0x71, 0x72</p> <p>2. Add 0x90 Game Mode</p>		

		<ul style="list-style-type: none"> - Move to common section <p>3. 0xB6 DST (Daylight Saving Time) Control</p> <ul style="list-style-type: none"> - Change Weekday code of DST(Rollback it as code of v13.2) <p>4. 0xCA System Menu Control</p> <ul style="list-style-type: none"> - Add sub 0x60 SBOX Mode - Add sub 0x61 Dimming Mode - Add sub 0x62 Night Time Constant Brightness - Add sub 0x63 Brightness Change Period - Add sub 0x64 Light Sensor Effective Range - Add sub 0x65 Brightness Output Range - Add sub 0x66 Latitude / longitude Info - 0xA1 No Signal Power Off : Add option for 10min <p>5. 0xD0 Led Product features</p> <ul style="list-style-type: none"> - Sub 0x9A Data Reload : Add option for RM data as 0x04 <p>6. 0xD2 Large Sized Data Control</p> <ul style="list-style-type: none"> - Add sub 0x20 File Download & Install 		
--	--	---	--	--

1. Interface

1.1. Connection Method

There are 2 available ways of connecting. One is RS232, the other is RJ45.

1.1.1 Connection method (with RS232)

- As of Figure 1-1, connect RS232-In(9Pin) to Personal Computer,
- connect the next TV or Display to be connected from RS232-Out (9Pin).
- In doing so, each device can be given from 0 to 253.
- (Depends on the product actual range can be differ)
- ID cannot be given duplicated.
- When granting ID, it does not need to be given out in the connecting order.

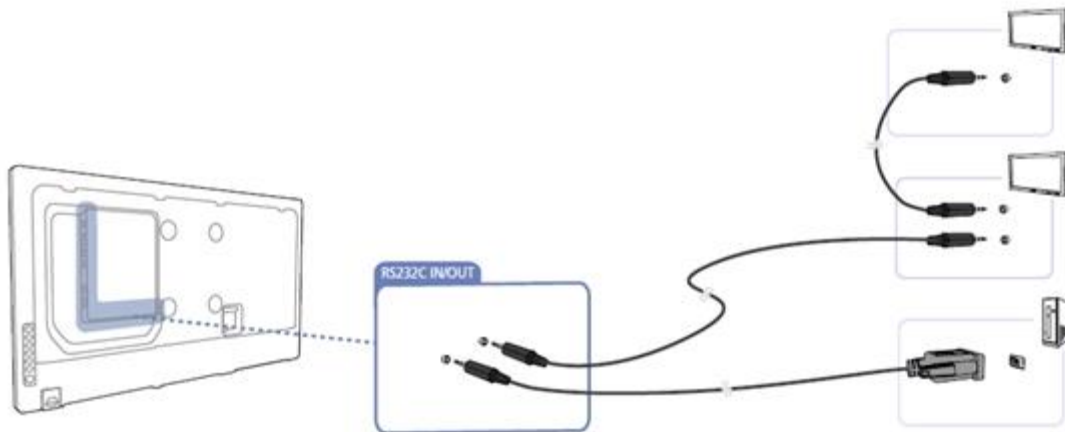

Figure1-1 PC,TV or Monitor connecting method(with RS232)

1.1.2 Connecting method(with RJ45)

- There are several ways to connect Personal Computer and TV(or Monitor).
- As of Figure 1-2, connect Hub and Personal Computer(using Ethernet).
Connect each TV of Display to be connected to the Hub.
- In doing so, each TV or Monitor must have an IP address.
- TV or Monitor connected by protocol's IP address must have the same ID with the protocol's ID.
- Each TV or Monitor ID can be duplicated.

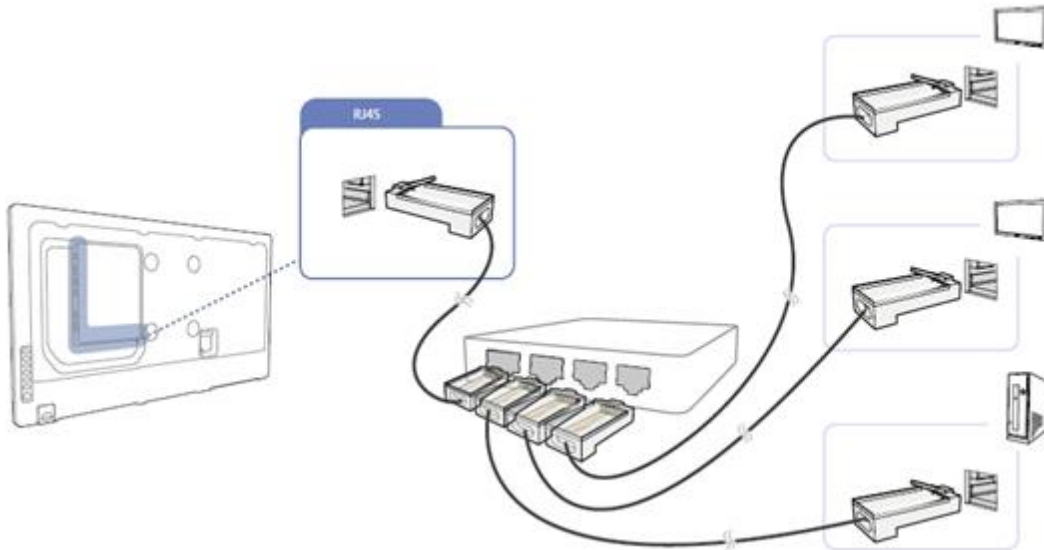

Figure1-2 PC,TV or Monitor connecting method(with RJ45)

1.1.3 Connecting method(with RJ45 & RS232C)

- As of Figure 1-3, connect TV and Personal Computer(using Ethernet), connect the next TV of Display to be connected from RS232-Out (9Pin).
- In doing so, only TV(connected to Personal Computer) needs an IP address. And each device ID can be given from 0 to 253.
- ID cannot be given duplicated.
- When granting ID, it does not need to be given out in the connecting order.

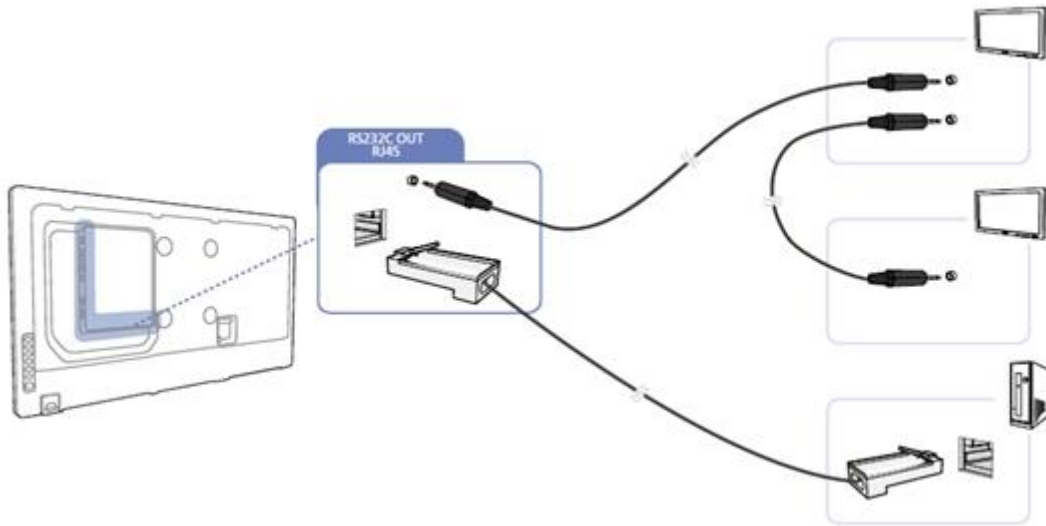

Figure1-3 PC,TV or Monitor connecting method(with RJ45 & RS232C)

1.2. Connection Spec

1.2.1 RS232 Connection Spec.

- Interactive communications using RS232.
- Of RS232 standards, three signals RxD(No.2), TxD(No.3) and GND(No.5) are used
→ Refer to Figure 2-1
- Limit the distance between devices to less than 4m.
- Currently, out of 9 PIN RS232 terminal, PINS in use are numbers 2, 3 and 5.
- ID should show hexadecimal value of assigned ID.
- Every communication will be made in hexadecimal and Checksum is the sum of all remainings. If it exceeds two digits, for example, it is 11+FE+01+01=111, discard the number in the first digit like below.

Example) Power On & ID=FE

Header	Command	ID	Data Length	Data 1	Check Sum
0xAA	0x11		1	Power	

→

Header	Command	0xFE	Data Length	Data 1	11
0xAA	0x11		1	1	

- If you want to control every mechanism connected with Serial Cable regardless of its ID, set ID part to "0xFE" and send commands. At the time, each SET will follow commands but it will not respond with ACK.

Table 2-1 RS232 Network spec

Bits Rate	9600 bps
Data Bits	8 bits
Parity	None
Stop Bits	1 bit
Flow Control	None

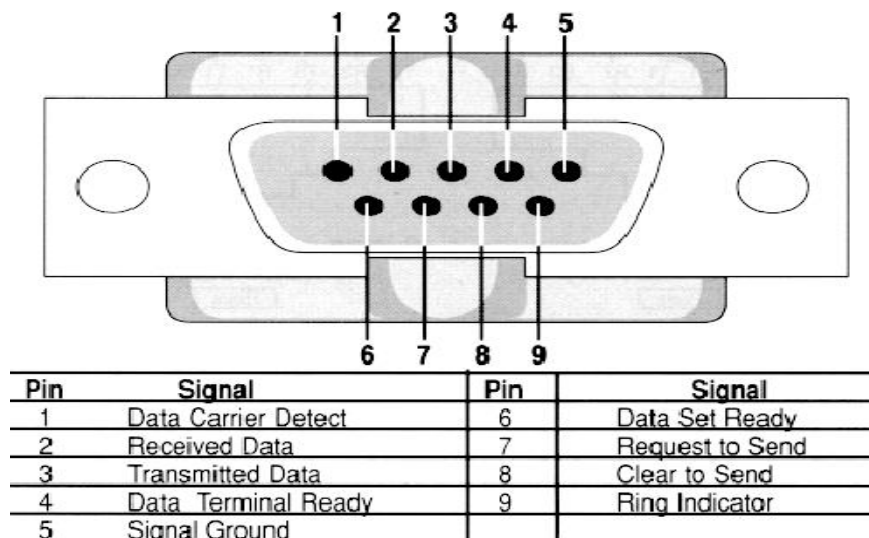

Figure 2-1 RS-232 pin out DB-9 pin used for Asynchronous Data

1.2.2 RJ45 Connection Spec.

- Interactive communications using RJ45.
- Transmit the MDC protocol using TCP/IP Format. The protocol information is stored in data area.
- The protocol information format is the same as RS232's.
example) Power Off & ID=0

Header	Command	ID	Data Length	Data1	Checksum
0xAA	0x11		1	Power	
TCP			UDP		
IP	ICMP	ARP	RARP		
Hardware Interface(Ethernet, PPP etc.)					

→

Header	Command	0xFE	Data Length	Data1	10
0xAA	0x11		1	0	
TCP			UDP		
IP	ICMP	ARP	RARP		
Hardware Interface(Ethernet, PPP etc.)					

- default ip : 192.168.0.10 PORT : 1515
- The RJ45 plug has 8-Pins as below.

Table 2-2 RJ45 plug 8-Pins

RJ45 PIN#	Wire Color(T568A)	10Base-T Signal 100Base-TX Signal	1000Base-T Signal
1	White/Green	Transmit+	BI_DA+
2	Green	Transmit-	BI_DA-
3	White/Orange	Receive+	BI_DB+
4	Blue	Unused	BI_DC+
5	White/Blue	Unused	BI_DC-
6	Orange	Receive-	BI_DB-
7	White/Brown	Unused	BI_DD+
8	Brown	Unused	BI_DD-

2. Command

[Note]

- If a certain field is not supported by product spec,
 For set functionality, incoming data will be ignored
 For get functionality, not supported field will be return as 0xff and
 if it is not available to sue 0xff for not supported it will be described on each command
- Err code on NAK reply.
 Error code data is used for internal purpose and can be differ by command and model.

[Command Table]

Command No	Command Type	Sub Command	Data Type
0x00	Status Control		Multi Param
0x04	Video Control		Multi Param
0x06	RGB Control		Multi Param
0x07	PIP Status Control		Multi Param
0x08	Maintenance Control		Multi Param
0x09	Sound Control		Multi Param
0x0B	Serial Number Control		String
0x0D	Display Status Control		Multi Param
0x0E	SW Version Control		String
0x0F	Auto Motion Plus		Multi Param
0x10	Model Number Control		Multi Param
0x11	Power Control		Discrete
0x12	Volume Control		0 ~ 100
0x13	Mute Control		0, 1
0x14	Input Source Control		Discrete
0x15	Image Size Control		Discrete
0x17	Direct Channel Control (DTV)		Multi Param
0x18	Screen Mode Control		Discrete
0x19	Screen Size Control		Discrete
0x1A	Outdoor	0x81 : Outdoor Mode	0, 1
		0x82 : Internal HeatEx Fan Speed Control	Discrete
0x1B	System Configuration	0x82 : Network Configuration	Multi Param
		0x85 : Network IP Mode	Discrete
		0x8A : Network Access Point Configuration	String

		0xA2 : Weekly restart	Discrete
		0xA4 : Check Software Version	Multi Param
0x1C	MagicInfo Control	0x81 : MagicInfo Channel	Discrete
		0x82 : MagicInfo Server Settings	Discrete
		0x83 : MagicInfo Content Orientation	Discrete
0x1D	MDC Connection Type		Discrete
0x1F	Still Control		0, 1
0x21	Picture Control	0x01 : LED Picture Size	0, 1
		0x02 : Picture Size Custom Fit Size	Multi Param
		0x03 : HDR – Inverse Tone Mapping	0, 1
		0x04 : HDR – Dynamic Peaking	0, 1
		0x05 : HDR – Color Mapping	0, 1
		0x06 : Picture Size Fit To Screen	0, 1
		0x07 : HDMI UHD Color	Multi Param
		0x08 : FHD/UHD out control	0, 1
		0x09 : Live Mode Control	0, 1
		0x0A : HDR – Dynamic Range Extension	Discrete
		0x0B : 0B Screen Position	Discrete
		0x0C : HDR – MultiLink HDR	Multi Param
		0x50 : Color Enhancement	0, 1
		0x51 : Dynamic Backlight	0, 1
		0x52 : Fit To Screen	0, 1
		0x53 : Uniformity	0, 1
		0x54 : Gamma Mode	Discrete
0x55 : Black Equalizer	Discrete		
0x56 : HDR+	0, 1		
0x24	Contrast Control		0 ~ 100
0x25	Brightness Control		0 ~ 100
0x26	Sharpness Control		0 ~ 100
0x27	Color Control		0 ~ 100
0x28	Tint Control		0 ~ 100
0x2F	Coarse Control		0, 1
0x30	Fine Control		0, 1
0x31	H-Position Control		0, 1
0x32	V-Position Control		0, 1
0x33	Auto Power		0, 1
0x34	Clear Menu Control		0

0x36	Remote Control	0, 1	
0x37	RGB Contrast Control	0 ~ 100	
0x38	RGB Brightness Control	0 ~ 100	
0x3C	PIP On/Off Control	0, 1	
0x3D	Auto Adjustment Control	0	
0x3E	Color Tone Control	Discrete	
0x3F	Color Temperature Control	Discrete	
0x40	PIP Source Control	Discrete	
0x42	PIP Size Control	Discrete	
0x43	PIP Locate Control	Discrete	
0x44	Fan Speed Setting	0 ~ 100	
0x45	User Auto Color	0, 1	
0x47	Sound Select Control	0, 1	
0x48	Auto Volume	Discrete	
0x4A	Standby Control	Discrete	
0x4B	Video Picture Position & Size	Multi Param	
0x4C	Pixel Shift Control	Multi Param	
0x50	Sensor Control	0x00 : Light Sensor	Discrete
		0x01 : HeatEx Temperature	-60 ~ 125
		0x02 : LED Plate Temperature	-60 ~ 125
		0x03 : Final Duty	0 ~ 1023
0x51	EQ 100Hz Control	0 ~ 20	
0x52	EQ 300Hz Control	0 ~ 20	
0x53	EQ 1kHz Control	0 ~ 20	
0x54	EQ 3kHz Control	0 ~ 20	
0x55	EQ 10kHz Control	0 ~ 20	
0x56	Energy Saving_LFD	0, 1	
0x57	Auto Lamp Control	Multi Param	
0x58	Manual Lamp Control	0 ~ 100	
0x59	Safety Screen Run Control	Discrete	
0x5A	Inverse Control	0, 1	
0x5B	Safety Screen Control (MFM)	Multi Param	
0x5C	Video Wall Mode Control	0, 1	
0x5D	Safety Lock	0, 1	
0x5F	Key Lock Control (MFM)	0, 1	
0x61	Channel Up/Down	0, 1	

0x62	Volume Up/Down	0, 1
0x63	Ticker	Multi Param
0x65	Sound Select Control	0, 1
0x66	PC Module Detect	Discrete
0x67	Device Name	String
0x68	Speaker Select	0, 1
0x70	OSD Off/On	0, 1
0x71	P. Mode Control	Discrete
0x72	S. Mode Control	Discrete
0x73	Digital NR	Discrete
0x75	PC Color Tone Control	Discrete
0x76	Auto Auto Adjustment	0, 1
0x77	All Keys Lock	0, 1
0x78	SRS TSXT Control	0, 1
0x79	Film Mode	Discrete
0x83	Panel On Time	Multi Param
0x84	Video Wall On	0, 1
0x85	Temperature Control	75 ~ 124
0x86	Brightness Sensor	0, 1
0x87	Dynamic Contrast	Discrete
0x89	Video Wall User Control	Multi Param
0x8A	Model Name	String
0x8B	Video Wall Direct User Control	Multi Param
0x8C	Video Wall Feature Control	0x81 : Frame Alignment
0x8F	Fan	0, 1
0x90	Game Mode	0, 1
0x92	Energy Saving	Discrete
0x94	HDMI Black Level	0, 1
0x95	Black Adjust	Discrete
0x96	Gamma	Discrete
0x9C	Edge Enhancement	0, 1
0x9D	Color Space	Discrete
0x9E	xvYCC	0, 1
0x9F	Reset Control	Discrete
0xA1	Ambient Brightness Mode	Multi Param
0xA3	OSD Display Type On/Off	Multi Param

0xA4	Timer 1 Control_MFM		Multi Param
0xA5	Timer 2 Control_MFM		Multi Param
0xA6	Timer 3 Control_MFM		Multi Param
0xA7	Clock Control_MFM		Multi Param
0xA8	Holiday Add/Delete Control		Multi Param
0xA9	Holiday Get Control		Multi Param
0xAB	Timer4 Control		Multi Param
0xAC	Timer5 Control		Multi Param
0xAD	Timer6 Control		Multi Param
0xAE	Timer7 Control		Multi Param
0xAF	Edit Name Control		Discrete
0xB0	Virtual Remote Control		Discrete
0xB1	Display Port Daisy Chain		0, 1
0xB2	3Screen/4Screen Mode Control		Multi Param
0xB3	Video Conference Sound Mode Control		0, 1
0xB5	Network Standby Control		0, 1
0xB6	DST (Daylight Saving Time) Control		Multi Param
0xB7	Custom PIP Control		Multi Param
0xB8	Auto ID Setting Status Control		0, 1
0xB9	Display ID Information		0, 1
0xC5	Clock Control_MFM		Multi Param
0xC6	Eco Solution	0x81 : Auto Power Off	Discrete
		0x82 : Brightness Limit	Discrete
0xC7	Execute Launcher	0x81 : Launcher Mode	0, 1
		0x82 : URL Address	String
0xC8	OnScreen Display Menu Control	0x81 : Menu Orientation	Discrete
		0x82 : Source Orientation	Discrete
		0x83 : Aspect Ratio (Rotated)	Discrete
		0x84 : PIP Orientation	Discrete
		0x85: Menu Size	Discrete
0xC9	Sound Menu Control	0x81 : HDMI Sound	Multi Param
		0x82: EQ 200 Hz	0 ~ 20
		0x83: EQ 500Hz	0 ~ 20
		0x84: EQ 2kHz	0 ~ 20
		0x85: EQ 5kHz	0 ~ 20
0xCA	System Menu Control	0x60 : SBOX Mode	0,1
		0x61 : Dimming Mode	Discrete

		0x62 : Night Time Constant Brightness	0,1
		0x63 : Brightness Change Period	Discrete
		0x64 : Light Sensor Effective Range	Multi Param
		0x65 : Brightness Output Range & Default Output	Multi Param
		0x66 : Latitude / longitude Info	Multi Param
		0x70 : CEC On/Off	0,1
		0x81 : Auto Source Switch OnOff	0,1
		0x82 : Auto Source Switch Control	Multi Param
		0x83 : Power On Delay	Discrete
		0x84 : Synced Power On	0,1
		0x85 : Synced Power Off	0,1
		0x91 : Power Button	0, 1
		0x92 : Touch control Admin Lock	0, 1
		0x93 : DICOM Mode	0, 1
		0xA1 : No Signal Power Off	Discrete
		0xB0 : Eco Sensor Minimal Backlight	Discrete
0xD0	LED Product Feature	0x78 : Get LED Info	Discrete
		0x81 : Device Type	Multi Param
		0x82 : Input Source Info	Discrete
		0x83 : Product Info	Multi Param
		0x84 : Monitoring	Multi Param
		0x85 : ABL Mode	Discrete
		0x86 : Scanning Rate mode	0, 1
		0x87 : LOD ReCheck	0
		0x92 : Module WB(RGB) Control	0, 1
		0x93 : Cabinet WB(RGB) Control	Multi Param
		0x94 : Cabinet Backlight	Discrete
		0x95 : Cabinet Pixel WB(RGB) CC on/off	0, 1
		0x96 : Gamut Control	Discrete
		0x97 : Cabinet Seam Correction	Discrete
		0x98 : Cabinet Seam Correction on/off	0, 1
		0x99 : Module WB(RGB) on/off	0, 1
		0x9A : Pixel RGB Data Reload	Discrete
		0x9B : Block WB (RGB) Control	Multi Param
0x9C : Cabinet WB (RGB) Control	Multi Param		
0x9D : Block WB(RGB) on/off	0, 1		
0x9E : Cabinet WB(RGB) on/off	0, 1		

		0x9F : Multiple Edge Offset Control	Multi Param
		0xA2 : Block Gradation Control	Multi Param
		0xA3 : Block Gradation On/Off	Multi Param
		0xC2 : Get diagnosis Info	Discrete
		0xC3 : Auto ID	Multi Param
0xD2	Large Sized Data Control	0x20 : File Download & Install	Multi Param
0xE0	Net PIP Command		Multi Param
0xE4	Apply To Control		0, 1
0xF9	Panel On Off		0, 1
0xFD	Auto ID		Multi Param
0xFE	White Balance MDC Control	0x62 : White Balance Mode	Discrete
		0x81 : White Balance Red Gain	Discrete
		0x91 : White Balance Green Gain	Discrete
		0xA1 : White Balance Blue Gain	Discrete
		0xB1 : White Balance Red Offset	Discrete
		0xC1 : White Balance Green Offset	Discrete
		0xD1 : White Balance Blue Offset	Discrete
0xFF	ACK/NAK		Multi Param

Note : Depends on each model spec, a certain command will be supported or not
Depends on each model spec, an option of a certain command will be differ

2.1 Common Protocol

2.1.00 Status Control

- **Function**

Get the device various state like power, volume, sound mute, input source, picture aspect ratio, timer

- **Get**

Header	Command	ID	Data Length	Check Sum
0xAA	0x00		0x00	0x00

- **Set**

Not Support

- **Ack**

Header	Command	ID	Data Length	Ack/Nak	r-CMD	Val 1	Val 2
0xAA	0xFF		0x09	'A'	0x00	Power	Volume
Val 3	Val 4	Val 5	Val 6	Val 7	Check Sum		
Mute	Input	Aspect	N Time NF	F Time NF			

Power : Power code to be set on Device

Volume : Volume value code (0 ~ 100) to be set on Device

Mute : Mute code to be set on Device

Input : Input Source code to be set on TV/Monitor

Aspect : Image Size code to be set on TV/Monitor

Note :

1. If use New Timer (0xA4, 0xA5, 0xA6, 0xA7, 0xA8, 0xA9) command. Do as below.
 N Time NF : OnTime ON/OFF value of time to set TV/Monitor(old type Timer)
 F Time NF : OffTime ON/OFF value of time to set TV/Monitor(old type Timer)
 → It was supported for old type Timer. Now, It is always 0x00.
2. For no audio model volume and mute will be return as 0xff.

- **Nak**

Header	Command	ID	Data Length	Ack/Nak	r-CMD	Val 1	Check Sum
0xAA	0xFF		3	'N'	0x00	ERR	

ERR : Error code that shows what occurred error is

2.1.04 Video Control

- **Function**

Get the device picture settings like contrast, brightness, sharpness, color, tint, color tone, color temp

- **Working Condition**

1. ATV, DTV, AV, S-Video, Component, HDMI Only
2. A product which has **** Text , **** Video/Image and Calibration as picture mode,
It will not affected by the 1st condition and instead,
It will be work with **** Video/Image of picture mode in the menu

- **Get**

Header	Command	ID	Data Length	Check Sum
0xAA	0x04		ghost	0x00

- **Set**

Not Support

- **Ack**

Header	Command	ID	Data Length	Ack/Nak	r-CMD	Val 1	Val 2
0xAA	0xFF		ghost	0x0A	'A'	0x04	Contrast
Val 3	Val 4	Val 5	Val 6	Val 7	Val 8	Check Sum	
Sharpness	Color	Tint	ColorTone	ColorTemp	0		

Contrast : Contrast value to set the Device (0 ~ 100)

Brightness : Brightness value to set the Device (0 ~ 100)

Sharpness : Sharpness value to set the Device (0 ~ 100)

Color : Color value to set the Device (0 ~ 100)

Tint : Tint value to set the Device (0 ~ 100)

Color Tone : Color Tone value to set the Device

ColorTemp : Color Temperature value to set the Device

- **Nak**

Header	Command	ID	Data Length	Ack/Nak	r-CMD	Val 1	Check Sum
0xAA	0xFF		ghost	0x03	'N'	0x04	

ERR : Error code that shows what occurred error is

2.1.06 RGB Control

- **Function**

Get the device picture settings like contrast, brightness, color tone, color temperature, red gain, green gain, blue gain

- **Working Condition**

1. PC, BNC, DVI Only

(On the DVI source Red, Green, Blue Gain will not work)

r. A product which has **** Text , **** Video/Image and Calibration as picture mode, It will not be affected by the 1st condition and instead, It will work with **** Text of picture mode in the menu

- **Get**

Header	Command	ID	Data Length	Check Sum
0xAA	0x06		0x00	

- **Set**

Not Support

- **Ack**

Header	Command	ID	Data Length	Ack/Nak	r-CMD	Val 1	Val 2
0xAA	0xFF		0x0A	'A'	0x06	Contrast	Brightness
Val 3	Val 4	Val 5	Val 6	Val 7	Val 8	Check Sum	
ColorTone	ColorTemp	0	Red Gain	Green Gain	Blue Gain		

Val 1 ~ Val 8 : Same as above

Note : If LFD model doesn't support RGB Gain, those values should be replied with 0xFF. If then MDC application can ignore these values.

- **Nak**

Header	Command	ID	Data Length	Ack/Nak	r-CMD	Val 1	Check Sum
0xAA	0xFF		0x03	'N'	0x06	ERR	

ERR : Error code that shows what occurred error is

2.1.07 PIP Status Control

- **Function**

Get the device status of PIP related things like pip size, pip source

- **Get**

Header	Command	ID	Data Length	Check Sum
0xAA	0x07		0x00	

- **Set**

Not Support

- **Ack**

Header	Command	ID	Data Length	Ack/Nak	r-CMD	Val 1	Val 2
0xAA	0xFF		0x06	'A'	0x07	P.Size	P.Source
Val 3	Val 4	Check Sum					
0	0						

P.Size : The PIP size code set for the TV or monitor.

Note : For the detail, pls refer 0x42 PIP Size control command

P.Source : The PIP source code set for the TV or monitor.

- **Nak**

Header	Command	ID	Data Length	Ack/Nak	r-CMD	Val 1	Check Sum
0xAA	0xFF		0x03	'N'	0x07	ERR	

ERR : The error code indicating which error occurred.

2.1.08 Maintenance Control

- **Function**

Get the device status of power, pip size, pip source, lamp schedule things, burn protection timer things

Note : Depends on each model spec 0x15data length or 0x19 data length format will be supported

- **Get**

Header	Command	ID	Data Length	Check Sum
0xAA	0x08		0x00	

- **Set**

Not Support

- **Ack**

. Data Length 0x15

Header	Command	ID	Data Length	Ack/Nak	r-CMD	Val 1	Val 2
0xAA	0xFF		0x15	'A'	0x08	Power	P.Size
Val 3	Val 4	Val 5	Val 6	Val 7	Val 8	Val 9	Val 10
P.Source	Lmax_H	Lmax_M	Lmax_AP	LmaxValue	Lmin_H	Lmin_M	Lmin_AP
Val 11	Val 12	Val 13	Val 14	Val 15	Val 16	Val 17	Val 18
Lmin Value	Lamp Value	Screen Interval	Screen Time	Screen Type	V.Wall	V.Wall Format	V.Wall Divid
Val 19	Check Sum						
V.Wall Set							

. Data Length 0x19

Header	Command	ID	Data Length	Ack/Nak	r-CMD	Val 1	Val 2
0xAA	0xFF		0x19	'A'	0x08	Power	P.Size
Val 3	Val 4	Val 5	Val 6	Val 7	Val 8	Val 9	Val 10
P.Source	Lmax_H	Lmax_M	Lmax_AP	Lmax Value	Lmin_H	Lmin_M	Lmin_AP
Val 11	Val 12	Val 13	Val 14	Val 15	Val 16	Val 17	Val 18
Lmin Value	Lamp Value	Start Time - Hour	Start Time - Min	Screen Type	Start Time - am/pm	End Time - Hour	End Time - Min.
Val 19	Val 20	Val 21	Val 22	Val 23	Check Sum		
End Time - am/pm	V.Wall	V.Wall Format	V.Wall Divid	V.Wall Set			

Power : Power code set on Device

P.Size : PIP Size value code set on Device

P.Source : PIP Source value code set on Device

Note : In case of PIP source is not valid status, till 2018 year model it will return as 0x00 and from the 2019year model it will return as 0xff

Lmax_H : Auto Lamp Max Time Hour (1 ~ 12) set on Device

Lmax_M : Auto Lamp Max Time Minute (0 ~ 59) set on Device

Lmax_AP : Auto Lamp Max Time AM/PM set on Device

LmaxValue : Auto Lamp Max value (0 ~ 100) set on Device
Lmin_H : Auto Lamp Min Time Hour (1 ~ 12) set on Device
Lmin_M : Auto Lamp Min Time Minute (0 ~ 59) set on Device
Lmin_AP : Auto Lamp Min Time AM/PM set on Device
LminValue : Auto Lamp Min value (0 ~ 100, 0xFF) set on Device
LampValue : Manual Lamp Control value (0 ~ 100, 0xFF) set on Device
ScreenInterval : Safety Screen Interval (Per Hour, 0(off)~10) set on Device
ScreenTime : Safety Screen Time (Per Second, 0(off) ~5) set on Device
ScreenType : SBP Type Code set on Device

0x00	OFF	0x00	OFF
0x01		0x81	
0x02		0x82	
0x03	Scroll (Timer : Repeat)	0x83	Scroll (Timer : Interval)
0x04	Pixel (Timer : Repeat)	0x84	Pixel (Timer : Interval)
0x05	Bar (Timer : Repeat)	0x85	Bar (Timer : Interval)
0x06	Eraser (Timer : Repeat)	0x86	Eraser (Timer : Interval)
0x09	All White (Timer : Repeat)	0x89	All White (Timer : Interval)
0x0A	Pattern (Timer : Repeat)	0x8A	Pattern (Timer : Interval)
...		...	
0x10	Rolling Bar (Timer : Repeat)	0x90	Rolling Bar (Timer : Interval)
0x11	Fading Screen (Timer : Repeat)	0x91	Fading Screen (Timer : Interval)

Note : Bit 7 means timer type is interval or repeat one.

If the bit7 is 1 then it means a interval type timer and if it is 0 then it means a repeat type timer

Start Time-Hour : Start Time Hour value (1 ~ 12)
Start Time-Min : Start Time Minute value (0 ~ 59)
Start Time-am/pm : Start Time AM/PM (0 ~ 1), 1 : AM, 0 : PM
End Time-Hour : Start Time Hour value (1 ~ 12)
End Time-Min : Start Time Minute value (0 ~ 59)
End Time-am/pm : Start Time AM/PM (0 ~ 1), 1 : AM, 0 : PM
V.Wall : code set on Device
V.WallFormat : Video Wall Format code set on Device
V.WallDivid : Video Wall Divider code set on Device
V.WallSet : Video f Set Number code set on Device

Note : If LminValue is returned to 0xFF then Auto Lamp Control is OFF.

If LampValue is returned to 0xFF then Manual Lamp Control is OFF.

If videlwall related field returned as 0xFF then videowall is not supported

● Nak

Header	Command	ID	Data Length	Ack/Nak	r-CMD	Val 1	Check Sum
0xAA	0xFF		0x03	'N'	0x08	ERR	

ERR : Error code that shows what occurred error is

2.1.09 Sound Control

- **Function**

Get the device status of sound related things like volume, balance, equalizer, SRS

- **Get**

Header	Command	ID	Data Length	Check Sum
0xAA	0x09		0x00	

- **Set**

Not Support

- **Ack**

Note : Not supported item will be return as 0xff

[Type 1]

Header	Command	ID	Data Length	Ack/Nak	r-CMD	Val 1	Val 2
0xAA	0xFF		0x0D	'A'	0x09	Vol	Balance
Val 3	Val 4	Val 5	Val 6	Val 7	Val 8	Val 9	Val 10
100Hz	300Hz	1kHz	3kHz	10kHz	0	0	0
Val 11	Check Sum						
SRS							

Vol, Balance : Vol, Balance value set on Device

100Hz, 300Hz, 1kHz, 3kHz, 10kHz : Each the frequency of the Equalizer value set on Device

The mean value is 0x0A. Value range is 0 ~ 20. In LFD menu it varies from -10 to +10.

menu 0 value is 0x0a

menu -10 is 0x00

SRS : SRS TSXT On/Off value set on Device

[Type 2]

Header	Command	ID	Data Length	Ack/Nak	r-CMD	Val 1	Val 2
0xAA	0xFF		0x0C	'A'	0x09	Vol	Balance
Val 3	Val 4	Val 5	Val 6	Val 7	Val 8	Val 9	Val 10
100Hz	200Hz	500Hz	1kHz	2kHz	5kHz	10kHz	SRS
Check Sum							

Vol, Balance : Vol, Balance value set on Device

100Hz, 200Hz, 500Hz, 1kHz, 2kHz, 5kHz, 10kHz : Each the frequency of the Equalizer value set on device. The mean value is 0x0A. Value range is 0 ~ 20. Menu item 0 is matched with 0x0a on this command and menu item -10 is 0 as same

SRS : SRS TSXT On/Off value on device

- **Nak**

Header	Command	ID	Data Length	Ack/Nak	r-CMD	Val 1	Check Sum
0xAA	0xFF		0x03	'N'	0x09	ERR	

ERR : Error code that shows what occurred error is

2.1.0B Serial Number Control

- **Function**

Get the device serial number.

- **Get**

Header	Command	ID	Data Length	Check Sum
0xAA	0x0B		0x00	

- **Set**

Not Support

- **Ack**

Header	Command	ID	Data Length	Ack/Nak	r-CMD	Val 1	Val 2
0xAA	0xFF		0x14	'A'	0x0B	Data1	Data2
Val 3	Val 4	Val 5	Val 6	Val 7	Val 8	Val 9	Val 10
Data3	Data4	Data5	Data6	Data7	Data8	Data9	Data10
Val 11	Val 12	...	Val 15	Val 16	Val 17	Val 18	Check Sum
Data11	Data12	...	Data15	Data16	Data17	Data18	

Data 1 ~ Data 15 : Serial Number data of the device. It is string format one.

Data 16 ~ Data 18 : Reserved

- **Nak**

Header	Command	ID	Data Length	Ack/Nak	r-CMD	Val 1	Check Sum
0xAA	0xFF		0x03	'N'	0x0B	ERR	

ERR : Error code that shows what occurred error is

2.1.0D Display Status Control

- **Function**

Get the device status of lamp error, temperature error, brightness sensor error, input source signal sync error, board temperature, fan error

- **Get**

Header	Command	ID	Data Length	Check Sum
0xAA	0x0D		0x00	

- **Set**

Not Support

- **Ack**

Header	Command	ID	Data Length	Ack/Nak	r-CMD	Val 1	Val 2
0xAA	0xFF		0x08	'A'	0x0D	Lamp Error	Temperature Error
Val 3	Val 4	Val 5	Val 6	Check Sum			
Bright_Sensor Error	No_Sync Error	Cur_Temp	FAN Error				

Lamp Error : Lamp Error code (0 : Normal, 1 : Error) to be set on Device

Temperature Error : Temperature Error code (0: Normal, 1: Error) to be set on Device

Bright_Sensor Error : Bright Sensor Error code (0: NONE, 1: Error, 2: NORMAL) to be set on TV/Monitor

No_Sync Error: Sync Error code(0: Normal, 1: Error, No Sync, 2: Invalid) to be set on Device

Note : Invalid status will be replied with app source selected state

Error status will be replied with input signal of not supported resolution or no signal

Cur_Temp : Current temperature of Device (-60°C ~ 125°C)

Note : If there any read fail, temp value will be return as 0xff

Actual temperature range will be differ by each product spec

FAN Error

0x00	Normal	0x01	Error
0x02	Fan is not supported	-	-

Note : If any data field is returned as 0xff, means it is invalid one

Based on the product spec, this command replay can be over 1sec.

- **Nak**

Header	Command	ID	Data Length	Ack/Nak	r-CMD	Val 1	Check Sum
0xAA	0xFF		0x03	'N'	0x0D	ERR	

ERR : Error code that shows what occurred error is

2.1.0E SW Version Control

- **Function**

Get the device SW version

- **Get**

Header	Command	ID	Data Length	Check Sum
0xAA	0x0E		0x00	

- **Set**

Not Support

- **Ack**

Header	Command	ID	Data Length	Ack/Nak	r-CMD	Val 1	Val 2
0xAA	0xFF		0x34(MAX)	'A'	0x0E	Version1	Version2
Val 3	Val 4	Val 5	Val 6	Val 7	Val 8	Val 9	Val 10
Version3	Version4	Version5	Version6	Version7	Version8	Version9	Version10
Val 11	Val 12	Val 13	Val 14	Val 15	Check Sum
Version11	Version12	Version13	Version14	Version15	

Version1 ~ Version12 : Project Info. Of TV/Monitor

Version13 ~ Version50 : Software version of TV/Monitor

Note : Because Version information is variable, The Data Length 2~52 (0x34) is variably value (Real Value Val(0~50) +2 (Ack/Nak, r-CMD))

- **Nak**

Header	Command	ID	Data Length	Ack/Nak	r-CMD	Val 1	Check Sum
0xAA	0xFF		0x03	'N'	0x06	ERR	

ERR : Error code that shows what occurred error is

2.1.0F Auto Motion Plus

- **Function**

Get/Set the device status of auto motion plus mode, blur reduction, judder reduction

Note : It will be supported by product specifications.

For example, 120Hz Panel applied model.

- **Get**

Header	Command	ID	Data Length	Check Sum
0xAA	0x0F		0x00	

- **Set**

Header	Command	ID	Data Length	Data 1	Data 2	Data 3	Check Sum
0xAA	0x0F		0x03	Mode	Blur Reduction	Judder Reduction	

Mode

0x00	Off	0x01	Clear
0x02	Standard	0x03	Smooth
0x04	Custom	0x05	Demo
0x06	Auto	-	-

Blur reduction : It is only for "Mode: Custom". If "Mode" is not custom, then it is "don't care". (0 ~ 10)

Judder reduction : It is only for "Mode: Custom". If "Mode" is not custom, then it is "don't care". (0 ~ 10)

- **Ack**

Header	Command	ID	Data Length	Ack/Nak	r-CMD	Val 1	Val 2
0xAA	0xFF		0x05	'A'	0x0F	Mode	Blur Reduction
Val 3	Check Sum						
Judder Reduction							

Mode : Same as above

Blur Reduction, Judder Reduction :

Ack For Set command Type, Data2 and Data3 is same with Set command.

Ack For Get command Type, Date2 and Data2 is LFD's Value.(even If "Mode" is not custom.)

- **Nak**

Header	Command	ID	Data Length	Ack/Nak	r-CMD	Val 1	Check Sum
0xAA	0xFF		0x03	'N'	0x0F	ERR	

ERR : Error code that shows what occurred error is

2.1.10 Model Number Control

- **Function**

Get the device information of panel type, model number code, tuner support

- **Get**

Header	Command	ID	Data Length	Check Sum
0xAA	0x10		0x00	

- **Set**

Not Supported

- **Ack**

Header	Command	ID	Data Length	Ack/Nak	r-CMD	Val 1	Val 2
0xAA	0xFF		0x05	'A'	0x10	Species	Model
Val 3	Check Sum						
TV							

Species : Device 's Panel Type.

-	-	0x01	PDP
0x02	LCD	0x03	DLP
0x04	LED	0x05	CRT
0x06	OLED	-	-

Model : Device's Model Number.

Value	Model Name	Remarks		
		IC Vender	IC Name	Etc IC (Color Enhancer)
0x01	PPM50H2			
0x02	PPM42S2			
0x03	PS-42P2ST			
0x04	PS-50P2HT			
0x05	SyncMaster 400T			
0x06	SyncMaster 403T			
0x07	PPM42S3, SPD-42P3SM			
0x08	PPM50H3, SPD-50P3HM			
0x09	PPM63H3, SPD-63P3HM			
0x0A	PS-42P3ST			
0x0B	SyncMaster 323T			
0x0C	SyncMaster 403T - CT40CS(N)			
0x0D	PPMxxM5x			
0x0E	SyncMaster 320P(n) SyncMaster 400P(n) SyncMaster 460P(n)			
0x0F	-			

0x10	SyncMaster 320PX SyncMaster 400PX(n) SyncMaster 460PX(n)			
0x11	–			
0x12	–			
0x13	SyncMaster 400TX(n)	MSTAR	Lola	–
0x14	SyncMaster 570DX	MSTAR	Lola	–
0x15	SyncMaster 320DX(n) SyncMaster 400DX(n) SyncMaster 460DX(n) SyncMaster 700DX(n) SyncMaster 820DX(n)	MSTAR	Lola	–
0x16	SyncMaster 460TX(n)	MSTAR	Lola	–
0x17	SyncMaster 400UX(n) SyncMaster 460UX(n) SyncMaster 460DR(n)	MSTAR	Lola	–
0x18	SyncMaster 42TS SyncMaster 42PS SyncMaster P42HP	MSTAR	Lola	–
0x19	SyncMaster P50Hn	MSTAR	Lola	–
0x1A	SyncMaster P50F(n) SyncMaster P50FP	MSTAR	Lola	–
0x1B	SyncMaster P63F(n) SyncMaster P63FP	MSTAR	Lola	–
0x1C	SyncMaster 320MX(n)	MSTAR	Lola	–
0x1D	SyncMaster 400CX(n) SyncMaster 400MX(n) SyncMaster 400MP(n)	MSTAR	Lola	–
0x1E	–	–	–	–
0x1F	–	–	–	–
0x20	SyncMaster 460CX(n) SyncMaster 460MP(n)	MSTAR	Lola	–
0x21	SyncMaster 520DX(n)	MSTAR	Lola	–
0x22	SyncMaster 400Uxn–UD SyncMaster 460Uxn–UD	ST	Sequoia	–
0x23	SyncMaster 400FX(n)	MSTAR	Lola	–
0x24	SyncMaster 460DRn–A	MSTAR	Lola	–
0x25	SyncMaster 460Utn–UD	MSTAR	Lola	–
0x26	SyncMaster 460UT(n)	MSTAR	Lola	–
0x27	SyncMaster 320MX(n)–2 SyncMaster 320MP–2	MSTAR	Lola	–
0x28	SyncMaster 400MX(n)–2 SyncMaster 400FP(n)–2	MSTAR	Lola	–
0x29	SyncMaster 460MX(n)–2 SyncMaster 460FP(n)–2	MSTAR	Lola	–
0x2A	SyncMaster P42H–2	MSTAR	Lola	–
0x2B	SyncMaster P50HP	MSTAR	Lola	–
0x2C	SyncMaster P50FP	MSTAR	Lola	–
0x2D	SyncMaster P63FP	MSTAR	Lola	–
0x2E	SyncMaster 460Rn–S	MSTAR	Lola	–
0x2F	SyncMaster 400DXn–S	MSTAR	Lola	–
0x30	SyncMaster 460DXn–S	MSTAR	Lola	–
0x31	SyncMaster 400CX(n)–2	ST	Sequoia	–

	SyncMaster 460CX(n)-2			
0x32	SyncMaster 400DX(n)-2 SyncMaster 460DX(n)-2 SyncMaster 700DX(n)-2 SyncMaster 820DX(n)-2 SyncMaster 650MP(n)	ST	Sequoia	
0x33	SyncMaster 400UX(n)-2 SyncMaster 460UX(n)-2	ST	Sequoia	
0x34	SyncMaster 700DRn	MSTAR	Lola	
0x35	SyncMaster 230TSn SyncMaster 230MXn	MSTAR	Lola	
0x36	SyncMaster 460DMn			
0x37	SyncMaster 400Uxn-UD2 SyncMaster 460Uxn-UD2	ST	Sequoia	
0x38	SyncMaster P50HP-2	MSTAR	Lola	
0x39	SyncMaster P63FP-2	MSTAR	Lola	
0x3A	SyncMaster 400Exn	ST	Mars	
0x3B	SyncMaster 460Exn	ST	Mars	
0x3C	SyncMaster 550Exn	ST	Mars	
0x3D	SyncMaster 460UT(n)-2	ST	Mars	
0x3E	SyncMaster 550DX(n)	ST	Mars	
0x3F	SyncMaster 460CX(n)-3 SyncMaster 400CX(n)-3 SyncMaster 320CX(n)-3	ST	Mars	
0x40	SyncMaster 520LD	ST	Mars	
0x41	SyncMaster 460UX(n)-3 SyncMaster 400UX(n)-3 SyncMaster 400BX	ST	Mars	
0x42	SyncMaster 460TS(n)-3 SyncMaster 400TS(n)-3	ST	Mars	
0x43	SyncMaster 460UT(n)-UD2	ST	Mars	
0x44	UE46A/UE55A ME40A/ME46A/ME55A DE40A/DE46A/DE55A MD32B/MD40B/MD46B/MD55B ME32B/ME40B/ME46B ME55B/ME65B/ME75B	Samsung	Genoa-P	
	SL46B	Samsung	Genoa-P	ACM12
0x45	SyncMaster UD55A	ST	Mars	
0x46	DE40C/DE46C/DE55C UD46C/UD55C/ UE46C/UE55C/	Samsung	Echo-E	ACM12
0x47	SyncMaster UD22A	ST	Mars	
0x48	SyncMaster NL22B	ST	Mars	
0x49	MD32C, MD40C, MD46C, MD55C, ME95C	Samsung	Echo-P	STDP7310
0x4A	ED32C/ED40C/ED46C/ ED55C/ED65C/ED75C/ ED32D/ED40D/ED46D/ ED55D/ED65D/ED75D/	Novatek	NT72569(N T13)	

0x4B	SyncMaster LE32C SyncMaster LE46C SyncMaster LE55C	ST	Mars	
0x4C	SyncMaster UD46C-B	ST	Mars	
0x4D	ME32C/ME40C/ME46C/ME55C/	Samsung	Echo-E	
0x4E	SyncMaster UD55C-B	ST	Mars	ACM12
0x4F	DB22D/DB32D/DB40D/ DB48D/DB55D/DM32D/ OH46D/OH55D	Samsung	Golf-S	
0x50	DM40D/DM48D/DM55D DM65D/DM75D	Samsung	Golf-S	
	UE46D/UE55D	Samsung	Golf-S	ACM12
	DH40D/DH48D/DH55D	Samsung	Golf-S	
	OM46D/OM55D/OM75D	Samsung	Golf-S	ACM12
0x51	EB40D/EB48D	Novatek	NT72456(N T14L)	
0x52	SyncMasterQM55D SyncMasterQM85D SyncMasterQM50D SyncMasterQM40D SyncMasterQM105D	Mstar	SE13U	
0x53	EM65E/EM75E ED65E/ED75E	Novatek	NT72456 (NT14L)	
0x54	DH40E,DH48E,DH55E	Samsung	Golf-S	
	DM32E,DM40E,DM48E, DM55E,DM65E,DM75E	Samsung	Golf-S	
	DB32E,DB40E,DB48E,DB55E	Samsung	Golf-S	
	DM65E-BR, DM75E-BR, DM82E-BR	Samsung	Golf-S	
	PE40E,PE46E,PE55E	Samsung	Golf-S	ACM
	DM10E, OHE, OME, MLE, SHF	Samsung	Golf-S	
	UD46E-P, UD55E-P, UD55E-S	Samsung	Golf-S	ACM
0x55	RH48E, RH55E	Samsung	Golf-S	
0x56	SyncMaster UD46E-B SyncMaster UD55E-B SyncMaster UD46E-C SyncMaster UD46E-A SyncMaster UD55E-A SyncMaster UH55F-E SyncMaster UM55H-E SyncMaster UH46N-E SyncMaster UM46N-E	Novatek	SE15HV	ACM12
0x57	IL015E/ IL025E/IL20E/ILF/ISF	Novatek	NT14F	
0x58	SBB-ES	Samsung	GOLF-S	
0x59	DC32E / DC40E / DC48E / DC55E	Novatek	NT72456 (NT14L)	
0x5A	OM24E OH24E/OH75E	Samsung	Golf-S	-
0x5B	SBB-MT	Mstar	SE13U	
0x5C	DC32E-M / DC40E-M / DC48E-M / DC55E-M DC32E-H / DC40E-H / DC48E-H / DC55E-H	Novatek	NT72456 (NT14L)	
0x5D	QM49F / QM55F /QM65F / QM75F / QM98F	Mstar	SE13U	

0x5E	PM32F / PM43F / PM49F / PM55F / PH43F / PH49F / PF55F / ML55F-R / PH43F-P / PH49F-P / PH55F-P / PM43H / PM49H / PM55H	Samsung	Hawk-MU	NONE
0x5F	OM46F / OM55F / OH46F / OH55F	Samsung	Hawk-MU	NONE
0x60	DC90F	Novatek	NT16L	
0x61	UH46F5	Novatek	SE15HV	ACM12
0x62	OH85F	Mstar	SE13U	
0x63	DC43H / DC49H / DC55H	Novatek	NT14L	NONE
0x64	QMH / QHH / PMJ / PHJ / PBJ	Samsung	Kant-M	NONE
0x65	IFH	TI	AM3352	NONE
0x66	OHH	Samsung	Kant-M	NONE
0x67	RM49H	Novatek	NT14L	NONE
0x68	DC43J / DC49J	Novatek	NT14L	NONE
0x69	QMN / QBN / QEN / QHR / QMR / QMR-N / QBR / QBR-N / QBR-T / SHR / QET	Samsung	KantM2e	NONE
0x6A	OHN / OHN-K / OHN-D / OHN-DK / OMN-D / OHF-S	Samsung	KantM2e	NONE
0x6B	VMRNU	Samsung	KantM2e	ACM 12
0x6C	QER / QPR-8K	Samsung	MuseM	NONE
0x6D	BE43R, BE49R	Novatek	NT14L	NONE
0x6E	VH55R-R, VMT-U, VHT-E, VMT-E	Novatek	SE15HV	ACM12
0x6F	OMR	Samsung	MuseM	NONE
0x70	QPT-8K	Samsung	NikeM	NONE
0x71	QPA-8K / QPAN8K	Samsung	Oscar-P	NONE
0x72	QMA	Samsung	Muse-M	NONE

TV : Device's TV support/not support.

0x00	Support TV	0x01	Do not support TV
------	------------	------	-------------------

● **Nak**

Header	Command	ID	Data Length	Ack/Nak	r-CMD	Val 1	Check Sum
0xAA	0xFF			0x03	'N'	0x10	

ERR : Error code that shows what occurred error is

2.1.11 Power Control

● Function

Get/Set the device power state

● Get

Header	Command	ID	Data Length	Check Sum
0xAA	0x11		0x00	

● Set

Header	Command	ID	Data Length	Data 1	Check Sum
0xAA	0x11		0x01	Power	

Power : Power code to be set on Device

0x00	Power OFF	0x01	Power ON
0x02	Reboot		

● Ack

Header	Command	ID	Data Length	Ack/Nak	r-CMD	Val 1	Check Sum
0xAA	0xFF		0x03	'A'	0x11	Power	

Power : Same as above

● Nak

Header	Command	ID	Data Length	Ack/Nak	r-CMD	Val 1	Check Sum
0xAA	0xFF		0x03	'N'	0x11	ERR	

ERR : Error code that shows what occurred error is

Note :

- When you execute power on function by RJ45 MDC then you must re-connect a socket connection after 10 sec.
- When Monitor is Power Off status and connect by RJ45 Then you must transmit the WOL protocol instead of MDC protocol using TCP/IP Format for Power On. (In "Network Standby : Off" Condition(DMD/DBD/DHD/UED/DMD-S) and always (Other Models)
- If you send a MDC Command for "PowerOn" or "PowerOff" It must retry for 3 times every 2 Seconds until ACK command. If there is no ACK within 3 times, It means failure.

Please refer below explanation

s) SET POWER OFF

0xAA,0x11,0x01,0x00,0x0x12 : MONITOR 1

0xAA,0x11,0x02,0x00,0x0x13 : MONITOR 2

0xAA,0x11,0x01,0x00,0x0x12 : MONITOR 1

0xAA,0x11,0x02,0x00,0x0x13 : MONITOR 2

0xAA,0x11,0x01,0x00,0x0x12 : MONITOR 1

0xAA,0x11,0x02,0x00,0x0x13 : MONITOR 2

2) SET POWER ON

0xAA,0x11,0x01,0x01,0x0x13 : MONITOR 1

0xAA,0x11,0x02,0x01,0x0x14 : MONITOR 2

0xAA,0x11,0x01,0x01,0x0x13 : MONITOR 1

0xAA,0x11,0x02,0x01,0x0x14 : MONITOR 2

0xAA,0x11,0x01,0x01,0x0x13 : MONITOR 1

0xAA,0x11,0x02,0x01,0x0x14 : MONITOR 2

2.1.12 Volume Control

- **Function**

Get/Set the device volume

- **Get**

Header	Command	ID	Data Length	Check Sum
0xAA	0x12		0x00	

- **Set**

Header	Command	ID	Data Length	Data 1	Check Sum
0xAA	0x12		0x01	Volume	

Volume : Volume value to be set on device (0 ~ 100)

- **Ack**

Header	Command	ID	Data Length	Ack/Nak	r-CMD	Val 1	Check Sum
0xAA	0xFF		0x03	'A'	0x12	Volume	

Volume : Same as above

- **Nak**

Header	Command	ID	Data Length	Ack/Nak	r-CMD	Val 1	Check Sum
0xAA	0xFF		0x03	'N'	0x12	ERR	

ERR : Error code that shows what occurred error is

2.1.13 Mute Control

- **Function**

Get/Set the device sound mute

- **Get**

Header	Command	ID	Data Length	Check Sum
0xAA	0x13		0x00	

- **Set**

Header	Command	ID	Data Length	Data 1	Check Sum
0xAA	0x13		0x01	Mute	

Mute : Mute code to be set on device

0x00	Mute OFF	0x01	Mute ON
------	----------	------	---------

- **Ack**

Header	Command	ID	Data Length	Ack/Nak	r-CMD	Val 1	Check Sum
0xAA	0xFF		0x03	'A'	0x13	Mute	

Mute : Same as above

- **Nak**

Header	Command	ID	Data Length	Ack/Nak	r-CMD	Val 1	Check Sum
0xAA	0xFF		0x03	'N'	0x13	ERR	

ERR : Error code that shows what occurred error is

2.1.14 Input Source Control

- **Function**

Get/Set the device source which is shown on the screen

- **Get**

Header	Command	ID	Data Length	Check Sum
0xAA	0x14		0x00	

- **Set**

Header	Command	ID	Data Length	Data 1	Check Sum
0xAA	0x14		0x01	Input	

Input : Input Source code to be set on Device

0x04	S-Video	0x08	Component
0x0C	AV1 (AV)	0x0D	AV2
0x0E	Ext. (SCART1)	0x18	DVI
0x14	PC	-	-
0x1E	BNC	0x1F	DVI_VIDEO
0x20	Magicinfo	0x21	HDMI1
0x22	HDMI1_PC	0x23	HDMI2
0x24	HDMI2_PC	0x25	DispalyPort(DispalyPort1)
0x26	DispalyPort2	0x27	DispalyPort3
0x30	RF(TV)	0x31	HDMI3
0x32	HDMI3_PC	0x33	HDMI4
0x34	HDMI4_PC	-	-
0x40	TV (DTV)	-	-
0x50	Plug In Module	0x55	HDBaseT
0x56	OCM	-	-
0x60	Media/MagicInfo S	0x61	WiDi/Screen Mirroring
0x62	Internal/USB	0x63	URL Launcher
0x64	IWB	0x65	Web Browser
0x66	Remote Workspace	-	-

Note : DVI_VIDEO, HDMI1_PC, HDMI2_PC, HDMI3_PC, HDMI4_PC → Get Only

In the case of Magicinfo, only possible with models include Magicinfo.

In the case of TV, only possible with models include TV.

In case of AV2, Ext, only possible with models include AT2, Ext.

On Timer function, Do not use 0x61. And use 0x62 by Internal/USB

URL Launcher can be supported on DB/DM/DH/UE Model.

- **Ack**

Header	Command	ID	Data Length	Ack/Nak	r-CMD	Val 1	Check Sum
0xAA	0xFF		0x03	'A'	0x14	Input	

Input : Same as above

- Nak

Header	Command	ID	Data Length	Ack/Nak	r-CMD	Val 1	Check Sum
0xAA	0xFF		0x03	'N'	0x14	ERR	

ERR : Error code that shows what occurred error is

2.1.15 Picture Size Control

- **Function**

Get/Set the device picture size(aspect ratio)

- **Working Condition**

It will not work with Video Wall is On

- **Get**

Header	Command	ID	Data Length	Check Sum
0xAA	0x15		0x00	

- **Set**

Header	Command	ID	Data Length	Data 1	Check Sum
0xAA	0x15		0x01	Aspect	

Aspect : Picture Size code to be set on Device

PC Mode		Video Mode	
0x10	16 : 9	0x00	Auto Wide
0x18	4 : 3	0x01	16 : 9
0x20	Original Ratio	0x04	Zoom
0x21	21 : 9	0x05	Zoom1
0x22	Custom	0x06	Zoom2
		0x09	Just Scan(Screen Fit)
		0x0B	4 : 3
		0x0C	Wide Fit
		0x0D	Custom
		0x0E	Smart View 1
		0x0F	Smart View 2
		0x31	Wide Zoom
		0x32	21 : 9

Note :

- Some of the image sizes are not supported depending on input signals (720p, 1080i).
- For MFM model only possible for those include Europe TV if size is Auto Wide
- PC mode and Video mode definition

Product Type (Defined in Model Number Control)	PC Mode	Video Mode
0x01 ~ 0x4e, 0x51, 0x53, 0x59, 0x5c, 0x60	PC1, PC2, DVI, BNC, HDMI_PC, DP	AV, S-Video, Component, DVI_Video, HDMI_Video
0x4f, 0x50, 0x52, 0x54, 0x55, 0x56, 0x5a, 0x61, 0x62	PIC_MODE_PC	PIC_MODE_VIDEO
0x5E	Work as a PC Mode always	

- Depends on each model specification, all or some of the picture size mode will be available.

- **Ack**

Header	Command	ID	Data Length	Ack/Nak	r-CMD	Val 1	Check Sum
0xAA	0xFF		0x03	'A'	0x15	Aspect	

Aspect : Same as above

- Nak

Header	Command	ID	Data Length	Ack/Nak	r-CMD	Val 1	Check Sum
0xAA	0xFF		0x03	'N'	0x15	ERR	

ERR : Error code that shows what occurred error is

2.1.17 Direct Channel Control (DTV)

- **Function**

Get/Set the device channel of TV source. It covers ATV/DTV both

Note : Only works with models include TV

- **Get**

Header	Command	ID	Data Length	Check Sum
0xAA	0x17		0x00	

- **Set**

Header	Command	ID	Data Length	Data 1	Data 2	Data 3	Data 4
0xAA	0x17		0x08	Country	ATV_DTV	AirCable	CH_NUM (High)
Data 5	Data 6	Data 7	Data 8	Check Sum			
CH_NUM (Low)	Sel_Minor	Minor_CH (High)	Minor_CH (Low)				

- **Ack**

Header	Command	ID	Data Length	Ack/Nak	r-CMD	Val 1	Val 2
0xAA	0xFF		0x0A	'A'	0x17	Country	ATV_DTV
Val 3	Val 4	Val 5	Val 6	Val 7	Val 8	Check Sum	
AirCable	CH_NUM (Hgh)	CH_NUM (Low)	Sel_Minor	Minor_CH (Hgh)	Minor_CH (Low)		

Country : Select the country to be set on Device (0 : Korea, 1: USA, ...)

ATV_DTV : Select Analog TV and DTV to be set on Device (0 : Analog TV, 1: Digital TV)

AirCable : Select if TV is cabled or general (0 : general, 1: cabled)

CH_NUM : TV channel number to be set on Device (Analog TV : 1 ~ 135 , Digital TV : 0 ~ 999)

Sel_Minor : Select minor channel when DTV is to be set on Device

(0 : minor channel not selected. 1: minor channel selected.)

Minor_CH : Select minor channel number when DTV is to be set on Device(0 ~ 999.)

- **Nak**

Header	Command	ID	Data Length	Ack/Nak	r-CMD	Val 1	Check Sum
0xAA	0xFF		0x03	'N'	0x17	ERR	

ERR : Error code that shows what occurred error is

2.1.18 Screen Mode Control

- **Function**

Get/Set the device screen mode

Note : It will work on Video Wall Off, Landscape or Picture size is Auto Wide
Picture Size Auto Wide is only used on European Tuner Signal

- **Get**

Header	Command	ID	Data Length	Check Sum
0xAA	0x18		0x00	

- **Set**

Header	Command	ID	Data Length	Data 1	Check Sum
0xAA	0x18		0x01	ScrMode	

ScrMode : Screen Mode Code to be set on Device

0x01	16 : 9
0x04	Zoom
0x0B	4 : 3
0x31	Wide Zoom

- **Ack**

Header	Command	ID	Data Length	Ack/Nak	r-CMD	Val 1	Check Sum
0xAA	0xFF		0x03	'A'	0x18	ScrMode	

ScrMode : Same as above

- **Nak**

Header	Command	ID	Data Length	Ack/Nak	r-CMD	Val 1	Check Sum
0xAA	0xFF		0x03	'N'	0x18	ERR	

ERR : Error code that shows what occurred error is

2.1.19 Screen Size Control

- **Function**

Get the device screen size by inch unit

- **Get**

Header	Command	ID	Data Length	Check Sum
0xAA	0x19		0x00	

- **Set**

Not Support

- **Ack**

Header	Command	ID	Data Length	Ack/Nak	r-CMD	Val 1	Check Sum
0xAA	0xFF		0x03	'A'	0x19	Screen Size	

Screen Size : Screen size of Device (Range : 0 ~ 255, Unit : Inch)

- **Nak**

Header	Command	ID	Data Length	Ack/Nak	r-CMD	Val 1	Check Sum
0xAA	0xFF		0x03	'N'	0x19	ERR	

ERR : Error code that shows what occurred error is

2.1.1A Outdoor

- **Function**

Control the outdoor feature related things of the device

Note : Depends on each model spec it will be supported or not

- **Working Condition**

Depends on each model spec it will be supported or not

- **Sub Command Table**

Sub CMD	Function	Sub CMD	Function
-	-	0x81	Outdoor Mode
0x82	Internal HeatEx Fan Speed Control		

2.1.1A.81 Outdoor Mode

- **Function**

Get/Set the device outdoor mode.

Note : outdoor mode makes the backlight as on even under power off state. So the device temperature will not down under risky point and device will be protected

- **Get**

Header	Command	ID	Data Length	Sub CMD	Check Sum
0xAA	0x1A		0x01	0x81	

- **Set**

Header	Command	ID	Data Length	Sub CMD	Data1	Check Sum
0xAA	0x1A		0x02	0x81	Outdoor Mode	

Outdoor Mode

0x00	Off	0x01	On
------	-----	------	----

- **Ack**

Header	Command	ID	Data Length	Ack	r-CMD	Sub CMD	Val1
0xAA	0xFF		0x04	'A'	0x1A	0x81	Outdoor Mode
Check Sum							

Outdoor Mode : Same as above

- **Nak**

Header	Command	ID	Data Length	Nak	r-CMD	r-Sub Cmd	Val1
0xAA	0xFF		0x04	'N'	0x1A	0x81	ERR
Check Sum							

ERR : Error code that shows what occurred error is

2.1.1A.82 Internal HeatEx Fan Speed Control

- **Function**

Control the device internal heatex fan.

- **Get**

Header	Command	ID	Data Length	Sub CMD	Check Sum
0xAA	0x1A		0x01	0x82	

- **Set**

Header	Command	ID	Data Length	Sub CMD	Data1	Check Sum
0xAA	0x1A		0x02	0x82	Fan Speed	

Fan Speed : Data range will be 0~100

- **Ack**

Header	Command	ID	Data Length	Ack	r-CMD	Sub CMD	Val1
0xAA	0xFF		0x04	'A'	0x1A	0x82	Fan Speed
Check Sum							

Fan Speed : Same as above

- **Nak**

Header	Command	ID	Data Length	Nak	r-CMD	r-Sub Cmd	Val1
0xAA	0xFF		0x04	'N'	0x1A	0x82	ERR
Check Sum							

ERR : Error code that shows what occurred error is

2.1.1B System Configutarion

- **Function**

Control the system configuration related things of the device.

Note : Depends on each model spec it will be supported or not

- **Sub Command Table**

Sub CMD	Function	Sub CMD	Function
0x82	Network Configuration	-	-
-	-	0x85	NetworkIPMode Control
0x8A	Network Access Point Configuration	-	-
0xA2	Weekly Restart	-	-
0xA4	Check Software Version(Get Only)	-	-

2.1.1B.82 Network Configuration

● Function

Get/Set the device network configuration like ip address, subnet mask, gateway address, DNS server address

● Get

Header	Command	ID	Data Length	Sub CMD	Check Sum
0xAA	0x1B		0x01	0x82	

● Set

Header	Command	ID	Data Length	Sub CMD	Data1	Data2	Data3
0xAA	0x1b		0x11	0x82	IP Address 1 st Byte	IP Address 2 nd Byte	IP Address 3 rd Byte
Data4	Data5	Data6	Data7	Data8	Data9	Data10	Data11
IP Address 4 th Byte	Subnet Mask 1 st Byte	Subnet Mask 2 nd Byte	Subnet Mask 3 rd Byte	Subnet Mask 4 th Byte	Gateway Address 1 st Byte	Gateway Address 2 nd Byte	Gateway Address 3 rd Byte
Data12	Data13	Data14	Data15	Data16	Check Sum		
Gateway Address 4 th Byte	DNS Server Address 1 st Byte	DNS Server Address 2 nd Byte	DNS Server Address 3 rd Byte	DNS Server Address 4 th Byte			

IP Address 1st Byte ~4th Byte : IP address data.

Subnet Mask 1st Byte ~4th Byte : Subnet mask data.

Gateway Address 1st Byte ~4th Byte : Gateway address data.

DNS Server Address 1st Byte ~4th Byte : DNS Server address data.

NOTE : 1st byte of each data will be a MSB

If IP address is 192.168.0.100 then 1st byte data will be a 0xc0 and 4th byte will be a 0x64

● Ack

Header	Command	ID	Data Length	Ack	r-CMD	Sub CMD	Val1
0xAA	0xFF		0x13	'A'	0x1B	0x82	IP Address 1 st Byte
Val2	Val3	Val4	Val5	Val6	Val7	Val8	Val9
IP Address 2 nd Byte	IP Address 3 rd Byte	IP Address 4 th Byte	Subnet Mask 1 st Byte	Subnet Mask 2 nd Byte	Subnet Mask 3 rd Byte	Subnet Mask 4 th Byte	Gateway Address 1 st Byte
Val10	Val11	Val12	Val13	Val14	Val15	Val16	Check Sum
Gateway Address 2 nd Byte	Gateway Address 3 rd Byte	Gateway Address 4 th Byte	DNS Server Address 1 st Byte	DNS Server Address 2 nd Byte	DNS Server Address 3 rd Byte	DNS Server Address 4 th Byte	

IP Address 1st Byte ~4th Byte : Same as above.

Subnet Mask 1st Byte ~4th Byte : Same as above.

Gateway Address 1st Byte ~4th Byte : Same as above.

DNS Server Address 1st Byte ~4th Byte : Same as above.

● Nak

Header	Command	ID	Data Length	Nak	r-CMD	r-Sub Cmd	Val1
0xAA	0xFF		0x04	'N'	0x1B	0x82	ERR
Check Sum							

ERR : Error code that shows what occurred error is

2.1.1B.85 NetworkIPMode Control

- **Function**

Get/Set the device network mode as dynamic or static

- **Get**

Header	Command	ID	Data Length	Sub CMD	Check Sum
0xAA	0x1B		0x01	0x85	

- **Set**

Header	Command	ID	Data Length	Sub CMD	Data1	Check Sum
0xAA	0x1B		0x02	0x85	NetWork IP Mode	

Network IP Mode

0x00	Dynamic	0x01	Static
------	---------	------	--------

- **Ack**

Header	Command	ID	Data Length	Ack	r-CMD	Sub CMD	Val1
0xAA	0xFF		0x04	'A'	0x1B	0x85	NetWork IP Mode
Check Sum							

Network IP Mode : Same as above

- **Nak**

Header	Command	ID	Data Length	Nak	r-CMD	r-Sub Cmd	Val1
0xAA	0xFF		0x04	'N'	0x1B	0x85	ERR
Check Sum							

2.1.1B.8A Network Access Point Configuration

- **Function**

Add a new SSID info to device connection history with its password

- **Get**

Not Supported

- **Set**

Header	Command	ID	Data Length	Ack	Data 1	Data 2	...
0xAA	0x1B		Variable	0x8A	Code1	Code1 Data1	...
Data 4			Val N	Check Sum	
Code1 DataN	...	CodeN	CodeN Data				

Code / Code Data

Code	Code Data
0x00 (SSID)	Data1 : Followed data Size Data2~ : String type data of access point SSID
0x01 (Password)	Data1 : Followed data Size Data2~ : String type data of access point password

- **Ack**

Header	Command	ID	Data Length	Ack	r-CMD	Sub CMD	Val 1
0xAA	0xFF		Variable	'A'	0x1B	0x8A	Code1
Val 2
Code1 Data			...	CodeN	CodeN Data		
Check Sum							

Code, Code Data : Same as above

- **Nak**

Header	Command	ID	Data Length	Nak	r-CMD	r-Sub Cmd	Val1
0xAA	0xFF		0x04	'N'	0x1B	0x8A	ERR
Check Sum							

2.1.1B.A2 Weekly Restart

- **Function**

Control the weekly restart schedule of the device

- **Get**

Header	Command	ID	Data Length	Sub CMD	Check Sum
0xAA	0x1B		0x01	0xA2	

- **Set**

Header	Command	ID	Data Length	Sub CMD	Data1	Data2	Data3
0xAA	0x1B		0x04	0xA2	Week Day	Time	Min

Check Sum

Week Day

Bit7	Bit6	Bit5	Bit4	Bit3	Bit2	Bit1	Bit0
Reserved	Monday	Tuesday	Wednesday	Thursday	Friday	Saturday	Sunday

Monday ~ Sunday : 0 – Do not restart, 1 – Do restart

Time : Restart time by hour (0 ~ 23), 0xff means invalid data

Min : Restart time by min (0 ~ 59), 0xff means invalid data

- **Ack**

Header	Command	ID	Data Length	Ack	r-CMD	Sub CMD	Val1
0xAA	0xFF		0x06	'A'	0x1B	0xA2	Week Day

Val2	Val3	Check Sum
Time	Min	

Week Day, Time, Min : Same as above

- **Nak**

Header	Command	ID	Data Length	Nak	r-CMD	r-Sub Cmd	Val1
0xAA	0xFF		0x04	'N'	0x1B	0xA2	ERR

Check Sum

ERR : Error code that shows what occurred error is

2.1.1B.A4 Check Software Version

- **Function**

Get the software version for the each and every HW module

- **Get**

Header	Command	ID	Length	Sub CMD	Check Sum
0xAA	0x1B		0x01	0xA4	

- **Set**

Not Supported

- **Ack**

Header	Command	ID	Data Length	Ack	r-CMD	Sub CMD	Val1
0xAA	0xFF		Variable	'A'	0x1B	0xA4	Number Of SW Ver Data
Val2	Val3	Val4	
1 st Data Type	1 st Data Length	1 st Version Data1	...	1 st Version DataN	...	N th Data Type	N th Data Length
...	Check Sum				
N th Version Data1	...	N th Version DataN					

Number Of SW Ver Data : Number of software version data info

1~Nth Data Type

0x00	Cabinet Main FW Data	0x01	Cabinet FPGA FW Data
0x02	Cabinet Calibration Data	0x03	SBOX FPGA FW Data
0x04	SBOX Valens FW Data	0x05	IG Valens FW Data
0x06	SBOX/MBOX FPGA2 FW Data	0x07	Cabinet Peripheral1(Sub Micom)
0x08	Cabinet Peripheral2(Reserved)	0x09	Cabinet Peripheral3(Reserved)
0x0A	Cabinet Peripheral4(Reserved)	0x0B	Cabinet Peripheral5(Reserved)
0x0C	Cabinet Peripheral6(Reserved)	0x0D	Cabinet Peripheral7(Reserved)
0x0E	Cabinet Peripheral8(Reserved)	0x0F	Cabinet Peripheral9(Reserved)
0x10	Cabinet Peripheral10(Reserved)	0x11	-

1~Nth Data Length : Each software version data length

1~Nth Version Data 1~N : String type data of each software version

- **Nak**

Header	Command	ID	Data Length	Ack	r-CMD	Sub CMD	Val1
0xAA	0xFF		0x04	'N'	0x1B	0xA4	Err
Check Sum							

Err : Error code that shows what occurred error is.

2.1.1C MagicInfo Control

- **Function**

Control the Magicinfo Player related things of the device

Note : Depends on each model spec it will be supported or not

- **Working Condition**

Depends on each model spec it will be supported or not

- **Sub Command Table**

Sub CMD	Function	Sub CMD	Function
		0x81	MagicInfo Channel Control
0x82	MagicInfo Server Settings	0x83	MagicInfo Content Orientation

2.2.1C.81 MagicInfo Channel Control

- **Function**

Set the device magicinfo channel which is used by MagicInfo S Player

- **Get**

Not Supported

- **Set**

Header	Command	ID	Data Length	Sub CMD	Data1	Data2	Check Sum
0xAA	0x1C		0x03	0x81	Direct CH Number		

Direct CH Number : MagicInfo channel number to set

- **Ack**

Header	Command	ID	Data Length	Ack	r-CMD	Sub CMD	Val1
0xAA	0xFF		0x05	'A'	0x1C	0x81	Direct CH Number High
Val2	Check Sum						
Direct CH Number Low							

Direct CH Number High and Low : Same as above

- **Nak**

Header	Command	ID	Data Length	Nak	r-CMD	r-Sub Cmd	Val1
0xAA	0xFF		0x04	'N'	0x1C	0x81	ERR
Check Sum							

ERR : Error code that shows what occurred error is

2.1.1C.82 MagicInfo Server Settings

- **Function**

Get/Set the MagicInfo Server URL and port settings of the device

- **Get**

Header	Command	ID	Data Length	Sub Cmd	Check Sum
0xAA	0x1C		0x01	0x82	

- **Set**

Header	Command	ID	Data Length	Sub CMD	Data1	...	DataN
0xAA	0x1C		Variable	0x82	Data 1	...	Data N
Check Sum							

Data1 ~ DataN If one wants to set as http format, set URL address as 10.88.8.73 and port 7001, Then Data 1 ~ N will be string data of <http://10.88.8.73:7001>

Note : URL address max length is limited 252 bytes

- **Ack**

Header	Command	ID	Data Length	Ack/Nak	r-CMD	Sub CMD	Val 1
0xAA	0xFF		Length	'A'	0x1C	0x82	Data 1
Val 2	Val 3	Val 4	Val 5	Val N	Check Sum		
Data 2	Data 3	Data N			

Data1 ~ DataN : Same as above.

Note : URL address max length is limited 252 bytes

If server address is set as more than 252 bytes length through menu, it will be returned only first 252 bytes data.

- **Nak**

Header	Command	ID	Data Length	Nak	r-CMD	r-Sub Cmd	Val1
0xAA	0xFF		0x04	'N'	0x1C	0x82	ERR
Check Sum							

ERR : Error code that shows what occurred error is

2.1.1C.83 MagicInfo Content Orientation

- **Function**

Get/Set the MagicInfo S Player content orientation of the device.

- **Get**

Header	Command	ID	Data Length	Sub Cmd	Check Sum
0xAA	0x1C		0x01	0x83	

- **Set**

Header	Command	ID	Data Length	Sub Cmd	Data 1	Check Sum
0xAA	0x1C		0x02	0x83	Orientation Mode	

Orientation Mode : Same as defined info on 0xc8 sub command 0x81

- **Ack**

Header	Command	ID	Data Length	Ack	r-CMD	Sub CMD	Val1
0xAA	0xFF		0x04	'A'	0x1C	0x83	Orientation Mode
Check Sum							

Orientation Mode : Same as defined info on 0xc8 sub command 0x81

- **Nak**

Header	Command	ID	Data Length	Ack	r-CMD	Sub CMD	Val1
0xAA	0xFF		0x04	'N'	0x1C	0x83	ERR
Check Sum							

ERR : Error code that shows what occurred error is

2.1.1D MDC Connection Type

- **Function**

Get/Set the device MDC Connection Type.

Note : Depends on product specifications it will support or not

Depends on the product specification, if it is set as RJ45 then serial MDC will not work.

- **Get**

Header	Command	ID	Data Length	Check Sum
0xAA	0x1D		0x00	

- **Set**

Header	Command	ID	Data Length	Data 1	Check Sum
0xAA	0x1D		0x01	Connection Type	

Connection Type

0x00	RS232C MDC	0x01	RJ45 MDC
------	------------	------	----------

- **Ack**

Header	Command	ID	Data Length	Ack/Nak	r-CMD	Val 1	Check Sum
0xAA	0xFF		0x03	'A'	0x1D	Connection Type	

Connection Type : Same as above

- **Nak**

Header	Command	ID	Data Length	Ack/Nak	r-CMD	Val 1	Check Sum
0xAA	0xFF		0x03	'N'	0x1D	ERR	

ERR : Error code that shows what occurred error is

2.1.1F Still control

- **Function**

Get/Set the device screen state as still

Note : Depends on product specifications it will support or not.
It will work only for the extern input source.

- **Get**

Header	Command	ID	Data Length	Check Sum
0xAA	0x1F		0x00	

- **Set**

Header	Command	ID	Data Length	Data 1	Check Sum
0xAA	0x1F		0x01	Still	

Still

0x00	Off	0x01	On
------	-----	------	----

- **Ack**

Header	Command	ID	Data Length	Ack/Nak	r-CMD	Val 1	Check Sum
0xAA	0xFF		0x03	'A'	0x1F	Still	

Still : Same as above

- **Nak**

Header	Command	ID	Data Length	Ack/Nak	r-CMD	Val 1	Check Sum
0xAA	0xFF		0x03	'N'	0x1F	ERR	

ERR : Error code that shows what occurred error is

2.1.21 Picture Control

- **Function**

Control the picture related things of the device

- **Working Condition**

Depends on each model spec it will be supported or not

- **Sub Command Table**

Sub CMD	Function	Sub CMD	Function
0x01	Picture Size Custom Fit	0x02	Picture Size Custom Fit Size
0x03	HDR – Inverse Tone Mapping	0x04	HDR – Dynamic Peaking
0x05	HDR – Color Mapping	0x06	Picture Size Fit To Screen
0x07	HDMI UHD color	0x08	FHD/UHD out control
0x09	Live Mode Control	0x0A	HDR – Dynamic Range Extension
0x0B	Screen Position	0x0C	HDR – MultiLink HDR
0x50	Color Enhancement	0x51	Dynamic Backlight
0x52	Fit To Screen	0x53	Uniformity
0x54	Gamma Mode	0x55	Black Equalizer
0x56	HDR+	–	–

2.1.21.01 LED Picture Size

- **Function**

Control the device output resolution to original or custom

- **Get**

Header	Command	ID	Data Length	Sub CMD	Check Sum
0xAA	0x21		0x01	0x01	

- **Set**

Header	Command	ID	Data Length	Sub CMD	Data1	Check Sum
0xAA	0x21		0x02	0x01	LED Picture Size	

LED Picture Size

0x00	Original	0x01	Custom
------	----------	------	--------

- **Ack**

Header	Command	ID	Data Length	Ack	r-CMD	Sub CMD	Val1
0xAA	0xFF		0x04	'A'	0x21	0x01	LED Picture Size
Check Sum							

LED Picture Size : Same as above

- **Nak**

Header	Command	ID	Data Length	Nak	r-CMD	r-Sub Cmd	Val1
0xAA	0xFF		0x04	'N'	0x21	0x01	ERR
Check Sum							

ERR : Error code that shows what occurred error is

2.1.21.02 Picture Size Custom Fit Size

- **Function**

Control the device custom output resolution

- **Get**

Header	Command	ID	Data Length	Sub CMD	Check Sum
0xAA	0x21		0x01	0x02	

- **Set**

Header	Command	ID	Data Length	Sub CMD	Data1	Data2	Data3
0xAA	0x21		0x05	0x02	Width		Height High Byte
Data4	Check Sum						
Height Low Byte							

Width: Custom screen width size

Height: Custom screen width size

Note : Depends on the producte spec, it will have a limitation for minimum/maximum size
Depends on the producte spec, it will have a limitation of 2pixel unit configutaion

- **Ack**

Header	Command	ID	Data Length	Ack	r-CMD	Sub CMD	Val1
0xAA	0xFF		0x07	'A'	0x21	0x02	Width High Byte
Val2	Val3	Val4	Check Sum				
Width Low Byte	Height						

Width : Same as above

Height : Same as above

- **Nak**

Header	Command	ID	Data Length	Nak	r-CMD	r-Sub Cmd	Val1
0xAA	0xFF		0x04	'N'	0x21	0x02	ERR
Check Sum							

ERR : Error code that shows what occurred error is

2.1.21.03 HDR – Inverse Tone Mapping

- **Function**

Control the device HDR – Inverse tone mapping. Inverse tone mapping makes dark elements of the image darker and the bright elements brighter.

- **Get**

Header	Command	ID	Data Length	Sub CMD	Check Sum
0xAA	0x21		0x01	0x03	

- **Set**

Header	Command	ID	Data Length	Sub CMD	Data1	Check Sum
0xAA	0x21		0x02	0x03	Inverse Tone Mapping	

Inverse Tone Mapping

0x00	Off	0x01	On
------	-----	------	----

- **Ack**

Header	Command	ID	Data Length	Ack	r-CMD	Sub CMD	Val1
0xAA	0xFF		0x04	'A'	0x21	0x03	Inverse Tone Mapping
Check Sum							

Inverse Tone Mapping : Same as above

- **Nak**

Header	Command	ID	Data Length	Nak	r-CMD	r-Sub Cmd	Val1
0xAA	0xFF		0x04	'N'	0x21	0x03	ERR
Check Sum							

ERR : Error code that shows what occurred error is

2.1.21.04 HDR – Dynamic Peaking

- **Function**

Control the device HDR – Dynamic Peaking. Dynamic peaking enlarges the difference of instantaneous maximum/minimum luminance

- **Get**

Header	Command	ID	Data Length	Sub CMD	Check Sum
0xAA	0x21		0x01	0x04	

- **Set**

Header	Command	ID	Data Length	Sub CMD	Data1	Check Sum
0xAA	0x21		0x02	0x04	Dynamic Peaking	

Dynamic Peaking

0x00	Off	0x01	On
------	-----	------	----

Note : Depends on the product spec, backlight control will not work with Dynamic peaking : on

- **Ack**

Header	Command	ID	Data Length	Ack	r-CMD	Sub CMD	Val1
0xAA	0xFF		0x04	'A'	0x21	0x04	Dynamic Peaking
Check Sum							

Dynamic Peaking : Same as above

- **Nak**

Header	Command	ID	Data Length	Nak	r-CMD	r-Sub Cmd	Val1
0xAA	0xFF		0x04	'N'	0x21	0x04	ERR
Check Sum							

ERR : Error code that shows what occurred error is

2.1.21.05 HDR – Color Mapping

- **Function**

Control the device HDR – Color Mapping. Color Mapping map the color of specific source image to target image color

- **Get**

Header	Command	ID	Data Length	Sub CMD	Check Sum
0xAA	0x21		0x01	0x05	

- **Set**

Header	Command	ID	Data Length	Sub CMD	Data1	Check Sum
0xAA	0x21		0x02	0x05	Color Mapping	

Color Mapping

0x00	Off	0x01	On
------	-----	------	----

- **Ack**

Header	Command	ID	Data Length	Ack	r-CMD	Sub CMD	Val1
0xAA	0xFF		0x04	'A'	0x21	0x05	Color Mapping
Check Sum							

Color Mapping : Same as above

- **Nak**

Header	Command	ID	Data Length	Nak	r-CMD	r-Sub Cmd	Val1
0xAA	0xFF		0x04	'N'	0x21	0x05	ERR
Check Sum							

ERR : Error code that shows what occurred error is

2.1.21.06 Picture Size Fit To Screen

- **Function**

Control the device custom output expansion to fit the screen

- **Get**

Header	Command	ID	Data Length	Sub CMD	Check Sum
0xAA	0x21		0x01	0x06	

- **Set**

Header	Command	ID	Data Length	Sub CMD	Data1	Check Sum
0xAA	0x21		0x02	0x06	Fit To Screen	

Fit To Screen

0x00	Off	0x01	On
------	-----	------	----

- **Ack**

Header	Command	ID	Data Length	Ack	r-CMD	Sub CMD	Val1
0xAA	0xFF		0x04	'A'	0x21	0x06	Fit To Screen
Check Sum							

Fit To Screen : Same as above

- **Nak**

Header	Command	ID	Data Length	Nak	r-CMD	r-Sub Cmd	Val1
0xAA	0xFF		0x04	'N'	0x21	0x06	ERR
Check Sum							

ERR : Error code that shows what occurred error is

2.1.21.07 HDMI UHD Color

- **Function**

Control device HDMI UHD Color. HDMI UHD color expands the input signal range for HDMI connection

Note : Depends on the product specification, it works as input signal plus

- **Get**

Header	Command	ID	Data Length	Sub CMD	Check Sum
0xAA	0x21		0x01	0x07	

- **Set**

Header	Command	ID	Data Length	Sub CMD	Data 1	Data 2	...
0xAA	0x21		Variable	0x07	Source1	HDMI UHD Color of source 1	...
Data N-1	Data N	Check Sum					
SourceN	HDMI UHD Color of Source N						

Source1 ~ N : Same as defined info on 0x14

HDMI UHD Color of Source 1 ~ N Value : 0x00(Off) , 0x01(On)

Note : Depends on the product spec some fo the source support this HDMI UHD color

If value change is happen with this, device reboot will be happen automatically

- **Ack**

Header	Command	ID	Data Length	Ack	r-CMD	Sub CMD	Val1
0xAA	0xFF		Variable	'A'	0x21	0x07	Source1
Val2	...	Val N-1	Val N	Check Sum			
HDMI UHD Color of source 1	...	SourceN	HDMI UHD Color of Source N				

Source1 ~ N : Same as defined info on 0x14

HDMI UHD Color of Source 1 ~ N Value : Same as above

- **Nak**

Header	Command	ID	Data Length	Ack	r-CMD	Sub CMD	Val1
0xAA	0xFF		0x04	'N'	0x21	0x07	Err
Check Sum							

Err : Error code that shows what occurred error is.

2.1.21.08 FHD/UHD out control

- **Function**

Control the device output resolution to FHD or UHD

- **Get**

Header	Command	ID	Data Length	Sub CMD	Check Sum
0xAA	0x21		0x01	0x08	

- **Set**

Header	Command	ID	Data Length	Sub CMD	Data 1	Check Sum
0xAA	0x21		0x02	0x08	Output	

Output

0x00	FHD	0x01	UHD
------	-----	------	-----

Note : If value change is happen, device reboot will be happen automatically

- **Ack**

Header	Command	ID	Data Length	Ack	r-CMD	Sub CMD	Val1
0xAA	0xFF		0x04	'A'	0x21	0x08	Output
Check Sum							

Output : Same as above

- **Nak**

Header	Command	ID	Data Length	Ack	r-CMD	Sub CMD	Val1
0xAA	0xFF		0x04	'N'	0x21	0x08	Err
Check Sum							

Err : Error code that shows what occurred error is.

2.1.21.09 Live Mode Control

- **Function**

Control the device live mode

- **Get**

Header	Command	ID	Data Length	Sub CMD	Check Sum
0xAA	0x21		0x01	0x09	

- **Set**

Header	Command	ID	Data Length	Sub CMD	Data 1	Check Sum
0xAA	0x21		0x02	0x09	Live Mode	

Live Mode

0x00	Normal	0x01	Live
------	--------	------	------

Note : If value change is happen, device reboot will be happen automatically

- **Ack**

Header	Command	ID	Data Length	Ack	r-CMD	Sub CMD	Val1
0xAA	0xFF		0x04	'A'	0x21	0x09	Live Mode
Check Sum							

Live Mode : Same as above

- **Nak**

Header	Command	ID	Data Length	Ack	r-CMD	Sub CMD	Val1
0xAA	0xFF		0x04	'N'	0x21	0x09	Err
Check Sum							

Err : Error code that shows what occurred error is.

2.1.21.0A HDR – Dynamic Range Extension

- **Function**

Control the device Dynamic Range Extension

- **Get**

Header	Command	ID	Data Length	Sub CMD	Check Sum
0xAA	0x21		0x01	0x0A	

- **Set**

Header	Command	ID	Data Length	Sub CMD	Data 1	Check Sum
0xAA	0x21		0x02	0x0A	Dynamic Range Extension	

Dynamic Range Extension

0x00	Off	0x01	Low
0x02	Medium	0x03	High

Note : If value change is happen, device reboot will be happen automatically

- **Ack**

Header	Command	ID	Data Length	Ack	r-CMD	Sub CMD	Val1
0xAA	0xFF		0x04	'A'	0x21	0x0A	Dynamic Range Extension
Check Sum							

Dynamic Range Extension : Same as above

- **Nak**

Header	Command	ID	Data Length	Ack	r-CMD	Sub CMD	Val1
0xAA	0xFF		0x04	'N'	0x21	0x0A	Err
Check Sum							

Err : Error code that shows what occurred error is.

2.1.21.0B Screen Position

- **Function**

Control the device custom output position

- **Get**

Header	Command	ID	Data Length	Sub CMD	Check Sum
0xAA	0x21		0x01	0x0B	

- **Set**

Header	Command	ID	Data Length	Sub CMD	Data1	Data2	Data3
0xAA	0x21		0x05	0x0B	Position X		Position Y High Byte
Data4	Check Sum						
Position Y Low Byte							

Position X : Screen x position data

Position Y : Screen y position data

Note : Depends on the producte spec, it will have a limitation for minimum/maximum size
Depends on the producte spec, it will have a limitation of 2pixel unit configutaion

- **Ack**

Header	Command	ID	Data Length	Ack	r-CMD	Sub CMD	Val1
0xAA	0xFF		0x07	'A'	0x21	0x0B	Position X High Byte
Val2	Val3	Val4	Check Sum				
Position X Low Byte	Position Y						

Position X, Position Y : Same as above

- **Nak**

Header	Command	ID	Data Length	Nak	r-CMD	r-Sub Cmd	Val1
0xAA	0xFF		0x04	'N'	0x21	0x0B	ERR
Check Sum							

ERR : Error code that shows what occurred error is

2.1.21.0C HDR – MultiLink HDR

- **Function**

Control the device multi link HDR

- **Get**

Header	Command	ID	Data Length	Sub CMD	Check Sum
0xAA	0x21		0x01	0x0C	

- **Set**

Header	Command	ID	Data Length	Ack	Data1	Data2	Data3
0xAA	0x21		0x04	0x0C	Multi Link HDR	Total Device Num	Device ID

Check Sum

Multi Link HDR

0x00	Off	0x01	On
------	-----	------	----

Total Device Num : Device num for multi link HDR

Device ID : Device ID under multi link HDR

Note : “0xFF Do not change” means do not change Multi Link HDR itself, but rest data are valid and need to handle it

- **Ack**

Header	Command	ID	Data Length	Ack	r-CMD	Sub CMD	Val1
0xAA	0xFF		0x06	'A'	0x21	0x0C	Multi Link HDR
Val2	Val3	Check Sum					
Total Device Num	Device ID						

Multi Link HDR, Total Device Num, Device ID : Same as above

- **Nak**

Header	Command	ID	Data Length	Nak	r-CMD	r-Sub Cmd	Val1
0xAA	0xFF		0x04	'N'	0x21	0x0C	ERR
Check Sum							

ERR : Error code that shows what occurred error is

2.1.21.50 Color Enhancement

- **Function**

Control the device color and sharpness enhancement mode

Note : Depends on the product spec, this will be worked as picture enhancement

- **Get**

Header	Command	ID	Data Length	Sub CMD	Check Sum
0xAA	0x21		0x01	0x50	

- **Set**

Header	Command	ID	Data Length	Sub CMD	Data 1	Check Sum
0xAA	0x21		0x02	0x50	Color Enhancement	

Color Enhancement

0x00	Off	0x01	On
------	-----	------	----

- **Ack**

Header	Command	ID	Data Length	Ack	r-CMD	Sub CMD	Val1
0xAA	0xFF		0x04	'A'	0x21	0x50	Color Enhancement
Check Sum							

Color Enhancement : Same as above

- **Nak**

Header	Command	ID	Data Length	Ack	r-CMD	Sub CMD	Val1
0xAA	0xFF		0x04	'N'	0x21	0x50	Err
Check Sum							

Err : Error code that shows what occurred error is.

2.1.21.51 Dynamic Backlight

- **Function**

Control the device dynamic backlight

Note : Depends on the product spec, this command can be work as Local Dimming control

- **Get**

Header	Command	ID	Data Length	Sub CMD	Check Sum
0xAA	0x21		0x01	0x51	

- **Set**

Header	Command	ID	Data Length	Sub CMD	Data 1	Check Sum
0xAA	0x21		0x02	0x51	Dynamic Backlight	

Dynamic Backlight

0x00	Off	0x01	On(Low)
0x02	Standard	0x03	High

- **Ack**

Header	Command	ID	Data Length	Ack	r-CMD	Sub CMD	Val1
0xAA	0xFF		0x04	'A'	0x21	0x51	Dynamic Backlight
Check Sum							

Dynamic Backlight : Same as above

- **Nak**

Header	Command	ID	Data Length	Ack	r-CMD	Sub CMD	Val1
0xAA	0xFF		0x04	'N'	0x21	0x51	Err
Check Sum							

Err : Error code that shows what occurred error is.

2.1.21.52 Fit To Screen

- **Function**

Control the device fit to Screen. Fit to screen makes the picture expansion to fit the screen

- **Get**

Header	Command	ID	Data Length	Sub CMD	Check Sum
0xAA	0x21		0x01	0x52	

- **Set**

Header	Command	ID	Data Length	Sub CMD	Data 1	Check Sum
0xAA	0x21		0x02	0x52	Fit To Screen	

Fit To Screen

0x00	Off	0x01	On
0x02	Auto	-	-

- **Ack**

Header	Command	ID	Data Length	Ack	r-CMD	Sub CMD	Val1
0xAA	0xFF		0x04	'A'	0x21	0x52	Fit To Screen
Check Sum							

Fit To Screen : Same as above

- **Nak**

Header	Command	ID	Data Length	Ack	r-CMD	Sub CMD	Val1
0xAA	0xFF		0x04	'N'	0x21	0x52	Err
Check Sum							

Err : Error code that shows what occurred error is.

2.1.21.53 Uniformity

- **Function**

Control the device uniformity mode

- **Get**

Header	Command	ID	Data Length	Sub CMD	Check Sum
0xAA	0x21		0x01	0x53	

- **Set**

Header	Command	ID	Data Length	Sub CMD	Data 1	Check Sum
0xAA	0x21		0x02	0x53	Uniformity Mode	

Uniformity Mode

0x00	Off	0x01	On
------	-----	------	----

Note : If value change is happen, device reboot will be happen automatically

- **Ack**

Header	Command	ID	Data Length	Ack	r-CMD	Sub CMD	Val1
0xAA	0xFF		0x04	'A'	0x21	0x53	Uniformity Mode
Check Sum							

Uniformity Mode : Same as above

- **Nak**

Header	Command	ID	Data Length	Ack	r-CMD	Sub CMD	Val1
0xAA	0xFF		0x04	'N'	0x21	0x53	Err
Check Sum							

Err : Error code that shows what occurred error is.

2.1.21.54 Gamma Mode

- **Function**

Control the device gamma mode. Gamma mode adjust the mid-range brightness of the picture

- **Get**

Header	Command	ID	Data Length	Sub CMD	Check Sum
0xAA	0x21		0x01	0x54	

- **Set**

Header	Command	ID	Data Length	Sub CMD	Data 1	Check Sum
0xAA	0x21		0x02	0x54	Gamma Mode	

Gamma Mode

0x00	HLG	0x01	ST.2084
0x02	BT.1886	0x03	S Curve

- **Ack**

Header	Command	ID	Data Length	Ack	r-CMD	Sub CMD	Val1
0xAA	0xFF		0x04	'A'	0x21	0x54	Gamma Mode
Check Sum							

Gamma Mode : Same as above

- **Nak**

Header	Command	ID	Data Length	Ack	r-CMD	Sub CMD	Val1
0xAA	0xFF		0x04	'N'	0x21	0x54	Err
Check Sum							

Err : Error code that shows what occurred error is.

2.1.21.55 Black Equalizer

- **Function**

Control the device black equalizer

- **Get**

Header	Command	ID	Data Length	Sub CMD	Check Sum
0xAA	0x21		0x01	0x55	

- **Set**

Header	Command	ID	Data Length	Sub CMD	Data 1	Check Sum
0xAA	0x21		0x02	0x55	Black Equalizer	

Black Equalizer

0x00	Off	0x01	Low
0x02	High	-	-

- **Ack**

Header	Command	ID	Data Length	Ack	r-CMD	Sub CMD	Val1
0xAA	0xFF		0x04	'A'	0x21	0x55	Black Equalizer
Check Sum							

Black Equalizer : Same as above

- **Nak**

Header	Command	ID	Data Length	Ack	r-CMD	Sub CMD	Val1
0xAA	0xFF		0x04	'N'	0x21	0x55	Err
Check Sum							

Err : Error code that shows what occurred error is.

2.1.21.56 HDR+

- **Function**

Control the device HDR+ mode. HDR+ makes an optimal HDR effect based on the video source

- **Get**

Header	Command	ID	Data Length	Sub CMD	Check Sum
0xAA	0x21		0x01	0x56	

- **Set**

Header	Command	ID	Data Length	Sub CMD	Data 1	Check Sum
0xAA	0x21		0x02	0x56	HDR+	

HDR+

0x00	Off	0x01	On
------	-----	------	----

- **Ack**

Header	Command	ID	Data Length	Ack	r-CMD	Sub CMD	Val1
0xAA	0xFF		0x04	'A'	0x21	0x56	HDR+
Check Sum							

HDR+ : Same as above

- **Nak**

Header	Command	ID	Data Length	Ack	r-CMD	Sub CMD	Val1
0xAA	0xFF		0x04	'N'	0x21	0x56	Err
Check Sum							

Err : Error code that shows what occurred error is.

2.1.24 Contrast Control

- **Function**

Control the device contrast. Contrast increase the light and dark color as the value increased

- **Working Condition**

1. AV, S-Video, Component, DVI(HDCP) Only
2. A product which has **** Text , **** Video/Image and Calibration as picture mode,
It will not affected by the 1st condition and instead,
It will not work with Calibration of picture mode in the menu

- **Get**

Header	Command	ID	Data Length	Check Sum
0xAA	0x24		0x00	

- **Set**

Header	Command	ID	Data Length	Data 1	Check Sum
0xAA	0x24		0x01	Contrast	

Contrast : Contrast value code to be set on TV/Monitor (0 ~ 100)

- **Ack**

Header	Command	ID	Data Length	Ack/Nak	r-CMD	Val 1	Check Sum
0xAA	0xFF		0x03	'A'	0x24	Contrast	

Contrast : Same as above

- **Nak**

Header	Command	ID	Data Length	Ack/Nak	r-CMD	Val 1	Check Sum
0xAA	0xFF		0x03	'N'	0x24	ERR	

ERR : Error code that shows what occurred error is

2.1.25 Brightness Control

- **Function**

Control the device brightness. Brightness increase the overall picture brightness as the value increased

- **Working Condition**

1. AV, S-Video, Component, DVI(HDCP) Only
2. A product which has **** Text , **** Video/Image and Calibration as picture mode, It will not affected by the 1st condition and instead, It will not work with Calibration of picture mode in the menu

- **Get**

Header	Command	ID	Data Length	Check Sum
0xAA	0x25		0x00	

- **Set**

Header	Command	ID	Data Length	Data 1	Check Sum
0xAA	0x25		0x01	Brightness	

Brightness : Brightness value code to be set on TV/Monitor (0 ~ 100)

- **Ack**

Header	Command	ID	Data Length	Ack/Nak	r-CMD	Val 1	Check Sum
0xAA	0xFF		0x03	'A'	0x25	Brightness	

Brightness : Same as above

- **Nak**

Header	Command	ID	Data Length	Ack/Nak	r-CMD	Val 1	Check Sum
0xAA	0xFF		0x0	'N'	0x25	ERR	

ERR : Error code that shows what occurred error is

2.1.26 Sharpness Control

- **Function**

Control the device sharpness. Sharpness increase as the value increased

- **Working Condition**

1. AV, S-Video, Component, DVI(HDCP) Only
2. A product which has **** Text , **** Video/Image and Calibration as picture mode,
It will not affected by the 1st condition and instead,
It will not work with Calibration of picture mode in the menu

- **Get**

Header	Command	ID	Data Length	Check Sum
0xAA	0x26		0x00	

- **Set**

Header	Command	ID	Data Length	Data 1	Check Sum
0xAA	0x26		0x01	Sharpness	

Sharpness : Sharpness value code to be set on TV/Monitor (0 ~ 100)

- **Ack**

Header	Command	ID	Data Length	Ack/Nak	r-CMD	Val 1	Check Sum
0xAA	0xFF		0x03	'A'	0x26	Sharpness	

Sharpness : Same as above

- **Nak**

Header	Command	ID	Data Length	Ack/Nak	r-CMD	Val 1	Check Sum
0xAA	0xFF		0x03	'N'	0x26	ERR	

ERR : Error code that shows what occurred error is

2.1.27 Color Control

- **Function**

Control the device color. Adjust the color saturation level

- **Working Condition**

1. AV, S-Video, Component, DVI(HDCP) Only
2. A product which has **** Text , **** Video/Image and Calibration as picture mode, it will not affect by the 1st condition and instead, It will be work with **** Video/Image of picture mode in the menu

- **Get**

Header	Command	ID	Data Length	Check Sum
0xAA	0x27		0x00	

- **Set**

Header	Command	ID	Data Length	Data 1	Check Sum
0xAA	0x27		0x01	Color	

Color : Color value code to be set on TV/Monitor(0 ~ 100)

- **Ack**

Header	Command	ID	Data Length	Ack/Nak	r-CMD	Val 1	Check Sum
0xAA	0xFF		0x03	'A'	0x27	Color	

Color : Same as above

- **Nak**

Header	Command	ID	Data Length	Ack/Nak	r-CMD	Val 1	Check Sum
0xAA	0xFF		0x03	'N'	0x27	ERR	

ERR : Error code that shows what occurred error is

2.1.28 Tint Control

- **Function**

Control the device tine. Adjust the ratio of green to red tint level

- **Working Condition**

1. AV, S-Video, Component, DVI(HDCP) Only
2. A product which has **** Text , **** Video/Image and Calibration as picture mode, it will not be affected by the 1st condition and instead, It will be work with **** Video/Image of picture mode in the menu

- **Get**

Header	Command	ID	Data Length	Check Sum
0xAA	0x28		0x00	

- **Set**

Header	Command	ID	Data Length	Data 1	Check Sum
0xAA	0x28		0x01	Tint	

Tint : Tint value code to be set on TV/Monitor (0 ~ 100)

R	Tint Value
G	(100 - Tint) Value

Note : Tint could only be set in 50 Steps (0, 2, 4, 6... 100)

- **Ack**

Header	Command	ID	Data Length	Ack/Nak	r-CMD	Val 1	Check Sum
0xAA	0xFF		0x03	'A'	0x28	Tint	

Tint : Same as above

- **Nak**

Header	Command	ID	Data Length	Ack/Nak	r-CMD	Val 1	Check Sum
0xAA	0xFF		0x03	'N'	0x28	ERR	

ERR : Error code that shows what occurred error is

2.1.2F Coarse Control

- **Function**

Set the device coarse.

Note : It is work only under PC source and when the videowall mode is set as on

- **Get**

Not Support

- **Set**

Header	Command	ID	Data Length	Data 1	Check Sum
0xAA	0x2F		0x01	Coarse	

Coarse : Coarse Increase/Decrease code to be set on TV/Monitor

0x00	Decrease	0x01	Increase
------	----------	------	----------

- **Ack**

Header	Command	ID	Data Length	Ack/Nak	r-CMD	Val 1	Check Sum
0xAA	0xFF		0x03	'A'	0x2F	Coarse	

Coarse : Same as above

- **Nak**

Header	Command	ID	Data Length	Ack/Nak	r-CMD	Val 1	Check Sum
0xAA	0xFF		0x03	'N'	0x2F	ERR	

ERR : Error code that shows what occurred error is

2.1.30 Fine Control

- **Function**

Set the device fine

Note : It is work only under PC source and when the videowall mode is set as on

- **Get**

Not Support

- **Set**

Header	Command	ID	Data Length	Data 1	Check Sum
0xAA	0x30		0x01	Fine	

Fine : Phase Increase/Decrease code

0x00	Decrease	0x01	Increase
------	----------	------	----------

- **Ack**

Header	Command	ID	Data Length	Ack/Nak	r-CMD	Val 1	Check Sum
0xAA	0xFF		0x03	'A'	0x30	Fine	

Fine : Same as above

- **Nak**

Header	Command	ID	Data Length	Ack/Nak	r-CMD	Val 1	Check Sum
0xAA	0xFF		0x03	'N'	0x30	ERR	

ERR : Error code that shows what occurred error is

2.1.31 H-Position Control

- **Function**

Control the device picture horizontal position

- **Note :**

- . This command can be worked as different way under specific condition
For the detail, pls refer Annex A.2
- . It works only under PC, BNC source and if videlwall or zoome is enabled it will not work

- **Get**

Header	Command	ID	Data Length	Check Sum
0xAA	0x31		0x00	

Note : Depends on the product spec it will work

- **Set**

Header	Command	ID	Data Length	Data 1	Check Sum
0xAA	0x31		0x01	H-Pos	

H-Pos : H-Position Increase/Decrease code to be set on TV/Monitor

0x00	Move to Left	0x01	Move to Right
------	--------------	------	---------------

- **Ack**

Header	Command	ID	Data Length	Ack/Nak	r-CMD	Val 1	Check Sum
0xAA	0xFF		0x03	'A'	0x31	H-Pos	

H-Pos : Same as above

- **Nak**

Header	Command	ID	Data Length	Ack/Nak	r-CMD	Val 1	Check Sum
0xAA	0xFF		0x03	'N'	0x31	ERR	

ERR : Error code that shows what occurred error is

2.1.32 V-Position Control

● Function

Control the device picture horizontal position

Note :

- . This command can be worked as different way under specific condition
For the detail, pls refer Annex A.3
- . It works only under PC, BNC source and if videlwall or zoome is enabled it will not work

● Get

Header	Command	ID	Data Length	Check Sum
0xAA	0x32		0x00	

Note : Depends on the product spec it will work

● Set

Header	Command	ID	Data Length	Data 1	Check Sum
0xAA	0x32		0x01	V-Pos	

V-Pos : V-Position Increase/Decrease code to be set on TV/Monitor

0x00	Move Up	0x01	Move Down
------	---------	------	-----------

● Ack

Header	Command	ID	Data Length	Ack/Nak	r-CMD	Val 1	Check Sum
0xAA	0xFF		0x03	'A'	0x32	V-Pos	

V-Pos : Same as above

● Nak

Header	Command	ID	Data Length	Ack/Nak	r-CMD	Val 1	Check Sum
0xAA	0xFF		0x03	'N'	0x32	ERR	

ERR : Error code that shows what occurred error is

2.1.33 Auto Power

- **Function**

Control the device auto power on functionality when attached to power source

- **Get**

Header	Command	ID	Data Length	Check Sum
0xAA	0x33		0x00	

- **Set**

Header	Command	ID	Data Length	Data 1	Check Sum
0xAA	0x33		0x01	Auto Power	

Auto Power : The Auto Power Control code to set for the TV or monitor

0x00	Auto Power Off	0x01	Auto Power On
------	----------------	------	---------------

- **Ack**

Header	Command	ID	Data Length	Ack/Nak	r-CMD	Val 1	Check Sum
0xAA	0xFF		0x03	'A'	0x33	Auto Power	

Auto Power : Same as above

- **Nak**

Header	Command	ID	Data Length	Ack/Nak	r-CMD	Val 1	Check Sum
0xAA	0xFF		0x03	'N'	0x33	ERR	

ERR : Error code that shows what occurred error is

2.1.34 Clear Menu Control

- **Function**

Clear the device showing menu

- **Get**

Not support

- **Set**

Header	Command	ID	Data Length	Data 1	Check Sum
0xAA	0x34		0x01	Clear	

Clear : 0x00 (Always)

- **Ack**

Header	Command	ID	Data Length	Ack/Nak	r-CMD	Val 1	Check Sum
0xAA	0xFF		0x03	'A'	0x34	Clear	

Clear : Same as above

- **Nak**

Header	Command	ID	Data Length	Ack/Nak	r-CMD	Val 1	Check Sum
0xAA	0xFF		0x03	'N'	0x34	ERR	

ERR : Error code that shows what occurred error is

2.1.36 Remote Control

- **Function**

Control the device remote control mode

Note : Can operate regardless of whether power is ON/OFF

(If DPMS Situation in LFD, it operate Remocon regardless of set value.)

- **Get**

Header	Command	ID	Data Length	Check Sum
0xAA	0x36		0x00	

- **Set**

Header	Command	ID	Data Length	Data 1	Check Sum
0xAA	0x36		0x01	RMC	

RMC : Power code to be set on TV/Remocon

0x00	Remocon Disable	0x01	Remocon Enable
------	-----------------	------	----------------

- **Ack**

Header	Command	ID	Data Length	Ack/Nak	r-CMD	Val 1	Check Sum
0xAA	0xFF		0x03	'A'	0x36	RMC	

RMC : Same as above

- **Nak**

Header	Command	ID	Data Length	Ack/Nak	r-CMD	Val 1	Check Sum
0xAA	0xFF		0x03	'N'	0x36	ERR	

ERR : Error code that shows what occurred error is

2.1.37 RGB Contrast Control

● Function

Control the device picture contrast

Note : Depends on the product spec,

1. PC, BNC, DVI Only
2. A product which has **** Text , **** Video/Image and Calibration as picture mode, It will not be affected by the 1st condition and instead, It will not work with Calibration of picture mode in the menu
3. It will work as same as with 0x24.Contrast Control

● Get

Header	Command	ID	Data Length	Check Sum
0xAA	0x37		0	

● Set

Header	Command	ID	Data Length	Data 1	Check Sum
0xAA	0x37		0x01	Contrast	

Contrast : RGB Contrast value code to be set on TV/Monitor (0 ~ 100)

● Ack

Header	Command	ID	Data Length	Ack/Nak	r-CMD	Val 1	Check Sum
0xAA	0xFF		0x03	'A'	0x37	Contrast	

Contrast : Same as above

● Nak

Header	Command	ID	Data Length	Ack/Nak	r-CMD	Val 1	Check Sum
0xAA	0xFF		0x03	'N'	0x37	ERR	

ERR : Error code that shows what occurred error is

2.1.38 RGB Brightness Control

- **Function**

Control the device picture brightness

Note : Depends on the product spec,

1. PC, BNC, DVI Only
2. A product which has **** Text , **** Video/Image and Calibration as picture mode, It will not be affected by the 1st condition and instead, It will not work with Calibration of picture mode in the menu
3. It will work as same with 0x25.Brightness Control

- **Get**

Header	Command	ID	Data Length	Check Sum
0xAA	0x38		0x00	

- **Set**

Header	Command	ID	Data Length	Data 1	Check Sum
0xAA	0x38		0x01	Brightness	

Brightness : RGB Brightness value code to be set on TV/Monitor (0 ~ 100)

- **Ack**

Header	Command	ID	Data Length	Ack/Nak	r-CMD	Val 1	Check Sum
0xAA	0xFF		0x03	'A'	0x38	Brightness	

Brightness : Same as above

- **Nak**

Header	Command	ID	Data Length	Ack/Nak	r-CMD	Val 1	Check Sum
0xAA	0xFF		0x03	'N'	0x38	ERR	

ERR : Error code that shows what occurred error is

2.1.3C PIP On/Off Control

- **Function**

Control the device PiP status

Note : This does not operate in MagicNet mode or videl wall mode is on

- **Get**

Header	Command	ID	Data Length	Check Sum
0xAA	0x3C		0x00	

- **Set**

Header	Command	ID	Data Length	Data 1	Check Sum
0xAA	0x3C		0x01	PIP	

PIP: The PIP On/Off code to set for the TV or monitor.

0x00	PIP OFF	0x01	PIP ON
------	---------	------	--------

- **Ack**

Header	Command	ID	Data Length	Ack/Nak	r-CMD	Val 1	Check Sum
0xAA	0xFF		0x03	'A'	0x3C	PIP	

PIP: Same as above.

- **Nak**

Header	Command	ID	Data Length	Ack/Nak	r-CMD	Val 1	Check Sum
0xAA	0xFF		0x03	'N'	0x3C	ERR	

ERR: The error code indicating which error occurred.

2.1.3D Auto Adjustment Control

- **Function**

Trigger the device picture auto adjustment

Note : It will work only under PC(D-Sub), BNC source and if the video wall mode is on then it will not work

– In case of video wall is on or picture size is Zoom, it will not work

- **Get**

Not Support

- **Set**

Header	Command	ID	Data Length	Data 1	Check Sum
0xAA	0x3D		0x01	Auto	

Auto : 0x00 (Always)

- **Ack**

Header	Command	ID	Data Length	Ack/Nak	r-CMD	Val 1	Check Sum
0xAA	0xFF		0x03	'A'	0x3D	Auto	

Auto : Same as above

- **Nak**

Header	Command	ID	Data Length	Ack/Nak	r-CMD	Val 1	Check Sum
0xAA	0xFF		0x03	'N'	0x3D	ERR	

ERR : Error code that shows what occurred error is

2.1.3E Color Tone Control

- **Function**

Control the device picture color tone

Note : Under a product which has **** Text , **** Video/Image and Calibration as picture mode, it will work with **** Video/Image of picture mode in the menu
Similar command is exist on 0x75 PC Color Tone Control

- **Get**

Header	Command	ID	Data Length	Check Sum
0xAA	0x3E		0x00	

- **Set**

Header	Command	ID	Data Length	Data 1	Check Sum
0xAA	0x3E		0x01	ColorTone	

Color Tone : Color Tone value code to be set on TV/Monitor (0 ~ 4)

0x00	Cool 2	0x01	Cool 1(Cool)
0x02	Normal(Standard)	0x03	Warm 1(Warm)
0x04	Warm 2	0x05	Natural
0x50	Off	-	-

- **Ack**

Header	Command	ID	Data Length	Ack/Nak	r-CMD	Val 1	Check Sum
0xAA	0xFF		0x03	'A'	0x3E	ColorTone	

Color Tone : Same as above

- **Nak**

Header	Command	ID	Data Length	Ack/Nak	r-CMD	Val 1	Check Sum
0xAA	0xFF		0x03	'N'	0x3E	ERR	

ERR : Error code that shows what occurred error is

2.1.3F Color Temperature Control

● **Function**

Control the device picture color temperature

Note :

- . Under a product which has **** Text , **** Video/Image and Calibration as picture mode, it will work calibration of picture mode
- . It will work when the color tone is off
- * For the PIC_MODE definition pls refer AnnexB

● **Get**

Header	Command	ID	Data Length	Check Sum
0xAA	0x3F		0x00	

● **Set**

Header	Command	ID	Data Length	Data 1	Check Sum
0xAA	0x3F		0x01	C.Temp (or Extended)	

C.Temp : Color Temperature value code to be set on TV/Monitor

0x00 ~ 0x0a	5000K ~ 15000K
0xFD	2800K
0xFE	3000K
0xFF	4000K

C.Temp (Extended) : Color Temperature value code to be set on TV/Monitor

28(0x1c)	2800K	95(0x5f)	9500K
30(0x1e)	3000K	100(0x64)	10000K
35(0x23)	3500K	105(0x69)	10500K
40(0x28)	4000K	110(0x6e)	11000K
45(0x2d)	4500K	115(0x73)	11500K
50(0x32)	5000K	120(0x78)	12000K
55(0x37)	5500K	125(0x7d)	12500K
60(0x3c)	6000K	130(0x82)	13000K
65(0x41)	6500K	135(0x87)	13500K
70(0x46)	7000K	140(0x8c)	14000K
75(0x4b)	7500K	145(0x91)	14500K
80(0x50)	8000K	150(0x96)	15000K
85(0x55)	8500K	155(0x9b)	15500K
90(0x5a)	9000K	160(0xa0)	16000K

Note : Depends on each model spec, it will work for the both of **C.Temp** and **C.Temp (Extended)** but in case of get it will returns as **C.Temp (Extended)**

● **Ack**

Header	Command	ID	Data Length	Ack/Nak	r-CMD	Val 1	Check
--------	---------	----	-------------	---------	-------	-------	-------

0xAA	0xFF		0x03	'A'	0x3F	C_Temp	Sum
------	------	--	------	-----	------	--------	-----

C_Temp : Same as above

- Nak

Header	Command	ID	Data Length	Ack/Nak	r-CMD	Val 1	Check Sum
0xAA	0xFF		0x03	'N'	0x3F	ERR	

ERR : Error code that shows what occurred error is

2.1.40 PIP Source Control

- **Function**

Control the device PIP source

Note : It will work only under PIP is on. And it will not work under MagicNet mode.

- **Get**

Header	Command	ID	Data Length	Check Sum
0xAA	0x40		0x00	

- **Set**

Header	Command	ID	Data Length	Data 1	Check Sum
0xAA	0x40		0x01	P.Source	

P.Source: The input source code to set for the TV or monitor.

Note : The PIP source swap may not function according to the main source.

- **Ack**

Header	Command	ID	Data Length	Ack/Nak	r-CMD	Val 1	Check Sum
0xAA	0xFF		0x03	'A'	0x40	P.Source	

P.Source: Same as above.

- **Nak**

Header	Command	ID	Data Length	Ack/Nak	r-CMD	Val 1	Check Sum
0xAA	0xFF		0x03	'N'	0x40	ERR	

ERR: The error code indicating which error occurred.

2.1.42 PIP Size Control

- **Function**

Control the device PIP size

Note : This does not operate in MagicNet mode.

- **Get**

Header	Command	ID	Data Length	Check Sum
0xAA	0x42		0x00	

- **Set**

Header	Command	ID	Data Length	Data 1	Check Sum
0xAA	0x42		0x01	P.Size	

P.Size : The PIP size code set for the TV or monitor.

0x00	PIP Off
0x04	Double 1(Doble Window)
0x05	Double 2(Double Wide)
0x06	Medium
0x07	Large
0x08	Small
0x09	Double 3(POP)
0x10	Custom

- **Ack**

Header	Command	ID	Data Length	Ack/Nak	r-CMD	Val 1	Check Sum
0xAA	0xFF		0x03	'A'	0x42	P.Size	

P.Size : Same as above.

- **Nak**

Header	Command	ID	Data Length	Ack/Nak	r-CMD	Val 1	Check Sum
0xAA	0xFF		0x03	'N'	0x42	ERR	

ERR: The error code indicating which error occurred.

2.1.43 PIP Locate Control

- **Function**

Control the device PIP window location

Note : It will not work under MagicInfo mode. And it will work only when the PIP is on

- **Get**

Header	Command	ID	Data Length	Check Sum
0xAA	0x43		0x00	

- **Set**

Header	Command	ID	Data Length	Data 1	Check Sum
0xAA	0x43		0x01	P.Locate	

P.Locate : The PIP Locate Increase/Decrease code to set for the TV or monitor.

0x00	PIP Off(Get Only)
0x01	Upper Left
0x02	Upper Right
0x03	Lower Right
0x04	Lower Left

- **Ack**

Header	Command	ID	Data Length	Ack/Nak	r-CMD	Val 1	Check Sum
0xAA	0xFF		0x03	'A'	0x43	P.Locate	

P.Locate : Same as above

- **Nak**

Header	Command	ID	Data Length	Ack/Nak	r-CMD	Val 1	Check Sum
0xAA	0xFF		0x03	'N'	0x43	ERR	

ERR: The error code indicating which error occurred.

2.1.44 Fan Speed Setting

- **Function**

Control the device fan speed

- **Get**

Header	Command	ID	Data Length	Check Sum
0xAA	0x44		0x00	

- **Set**

Header	Command	ID	Data Length	Data 1	Check Sum
0xAA	0x44		0x01	FAN Speed	

FAN Speed : The Fan Speed to set for the TV or monitor.(0 ~ 100)

Note : If you send "Set Fan speed", then "Fan Control" changed "Manual".

- **Ack**

Header	Command	ID	Data Length	Ack/Nak	r-CMD	Val 1	Check Sum
0xAA	0xFF		0x03	'A'	0x44	FAN Speed	

FAN Speed : Same as above

- **Nak**

Header	Command	ID	Data Length	Ack/Nak	r-CMD	Val 1	Check Sum
0xAA	0xFF		0x03	'N'	0x44	ERR	

ERR: The error code indicating which error occurred.

2.1.45 User Auto Color

- **Function**

Control the device user auto color

Note : It will work depending on product specifications.
It will work under PC(D-Sub) source only

- **Get**

Not Supported

- **Set**

Header	Command	ID	Data Length	Data 1	Check Sum
0xAA	0x45		0x01	Auto Color Cmd	

Auto Color Cmd : The Auto Color Cmd to set for the TV or monitor.

0x00	Reset	0x01	Auto Color
------	-------	------	------------

- **Ack**

Header	Command	ID	Data Length	Ack/Nak	r-CMD	Val 1	Check Sum
0xAA	0xFF		0x03	'A'	0x45	Auto Color Cmd	

Auto Color Cmd : Same as above

- **Nak**

Header	Command	ID	Data Length	Ack/Nak	r-CMD	Val 1	Check Sum
0xAA	0xFF		0x03	'N'	0x45	ERR	

ERR: The error code indicating which error occurred.

2.1.47 Sound Select Control

- **Function**

Control the device sound source as main or PIP

Note : Same function is also exist on 0x65, It will work only when the PIP is on

- **Get**

Header	Command	ID	Data Length	Check Sum
0xAA	0x47		0x00	

- **Set**

Header	Command	ID	Data Length	Data 1	Check Sum
0xAA	0x47		0x01	S.Select	

S.Select: The Sound Select code to set for the TV or monitor

0x00	Sub	0x01	Main
------	-----	------	------

- **Ack**

Header	Command	ID	Data Length	Ack/Nak	r-CMD	Val 1	Check Sum
0xAA	0xFF		0x03	'A'	0x47	S.Select	

S.Select: Same as above.

- **Nak**

Header	Command	ID	Data Length	Ack/Nak	r-CMD	Val 1	Check Sum
0xAA	0xFF		0x03	'N'	0x47	ERR	

ERR: The error code indicating which error occurred.

2.1.48 Auto Volume Control

- **Function**

Control the device volume adjustment mode to make the same sound level even with source or contents changing

- **Get**

Header	Command	ID	Data Length	Check Sum
0xAA	0x48		0x00	

- **Set**

Header	Command	ID	Data Length	Data 1	Check Sum
0xAA	0x48		0x01	A_VOL	

A_VOL : The Auto Volume code to set for the TV or monitor.

0x00	OFF
0x01	Normal(On)
0x02	Night

- **Ack**

Header	Command	ID	Data Length	Ack/Nak	r-CMD	Val 1	Check Sum
0xAA	0xFF		0x03	'A'	0x48	A_VOL	

A_VOL : Same as above

- **Nak**

Header	Command	ID	Data Length	Ack/Nak	r-CMD	Val 1	Check Sum
0xAA	0xFF		0x03	'N'	0x48	ERR	

ERR: The error code indicating which error occurred.

2.1.4A Standby Control

- **Function**

Control the device DPMS mode to make the device sleep with no signal status.

Note : It will work only under external input source

- **Get**

Header	Command	ID	Data Length	Check Sum
0xAA	0x4A		0x00	

- **Set**

Header	Command	ID	Data Length	Data 1	Check Sum
0xAA	0x4A		0x01	Standby Setting	

Standby Setting : The Standby Setting code to set for the TV or monitor

0x00	Off
0x01	On
0x02	Auto

- **Ack**

Header	Command	ID	Data Length	Ack/Nak	r-CMD	Val 1	Check Sum
0xAA	0xFF		0x03	'A'	0x4A	Standby Setting	

- **Nak**

Header	Command	ID	Data Length	Ack/Nak	r-CMD	Val 1	Check Sum
0xAA	0xFF		0x03	'N'	0x4A	ERR	

ERR: The error code indicating which error occurred.

2.1.4B Video Picture Position & Size

● Function

Control the device picture position and size

Note : Depends on the product spec,

1. Video Source Only
2. A product which has **** Text , **** Video/Image and Calibration as picture mode, it will not affect by the 1st condition and instead,
 - It will work in case of PIC_MODE is PIC_MODE_VIDEO
 - * For the PIC_MODE definition pls refer AnnexB
3. And “Picture Size” is must be zoom1, zoom2, Screen Fit, Custom. Other Picture sizes doesn’t support this function. (For detail, please refer below table.)

	Reset	Position				Size			
		0x00	0x01	0x02	0x03	0x00	0x01	0x02	0x03
Zoom1	O	O	O	X	X	X	X	X	X
Zoom2	O	O	O	X	X	X	X	X	X
Screen Fit	O	O	O	O	O	X	X	X	X
Custom	O	O	O	O	O	O	O	O	O
Zoom	O	O	O	X	X	X	X	X	X

● Get

Not support

● Set

Header	Command	ID	Data Length	Data 1	Data 2	Check Sum
0xAA	0x4B		0x02	Type CMD	Direction CMD	

Type CMD: The Standby Setting code to set for the TV or monitor

0x00	Reset	0x01	Position
0x02	Size	0x03	RESERVED

Direction CMD: It is work for Type CMD Size or Position.

If “Type CMD” is Reset, then “Direction CMD” is not work.

Direction CMD(Position)		Direction CMD(Size)	
0x00	Down	0x00	Vertical Scale Down
0x01	Up	0x01	Vertical Scale Up
0x02	Left	0x02	Horizontal Scale Down
0x03	Right	0x03	Horizontal Scale Up

● Ack

Header	Command	ID	Data Length	Ack/Nak	r-CMD	Val 1	Val 2
0xAA	0xFF		0x04	'A'	0x4B	Type CMD	Direction CMD
Check Sum							

Type CMD, Direction CMD : Same as Above

● Nak

Header	Command	ID	Data Length	Ack/Nak	r-CMD	Val 1	Check Sum
0xAA	0xFF		0x03	'N'	0x4B	ERR	

ERR: The error code indicating which error occurred.

2.1.4C Pixel Shift Control

- **Function**

Control the device pixel shift of screen burn protection function

Note : If video wall is on, zoom is on or input signal is vesa format on DVI source then it will not work

- **Get**

Header	Command	ID	Data Length	Check Sum
0xAA	0x4C		0x00	

- **Set**

Header	Command	ID	Data Length	Data 1	Data 2	Data 3	Data 4
0xAA	0x4C		0x04	Shift	H.Dot	V.Line	S.Time
Check Sum							

Shift : Pixel Shift On/Off Code to be set on TV/Monitor

Note : If **Shift** value is off, H.Dot, V.Line, S.Time values are ignored in Device.

0x00	OFF	0x01	ON
------	-----	------	----

H.Dot : Horizontal Dot value code set on TV/Monitor (0 ~ 4)

V.Line : Vertical Line value code set on TV/Monitor (0 ~ 4)

S.Time : Shift Time value code set on TV/Monitor (1 ~ 4)

- **Ack**

Header	Command	ID	Data Length	Ack/Nak	r-CMD	Val 1	Val 2
0xAA	0xFF		0x06	'A'	0x4C	Shift	H.Dot
Val 3	Val 4	Check Sum					
V.Line	S.Time						

Shift, H.Dot, V.Line, S.Time : Same as above

- **Nak**

Header	Command	ID	Data Length	Ack/Nak	r-CMD	Val 1	Check Sum
0xAA	0xFF		0x03	'N'	0x4C	ERR	

ERR : Error code that shows what occurred error is

2.1.50 Sensor Control

- **Function**

Control attached sensors

- **Working Condition**

Depends on each model spec it will be supported or not

- **Sub Command Table**

Sub CMD	Function	Sub CMD	Function
0x00	Light Sensor	0x01	HeatEx Temperature
0x02	LED Plate Temperature	0x03	Final Duty

2.1.50.00 Light Sensor

- **Function**

Get the device light sensor lux value

Note : Depends on each model spec it will be supported or not

- **Get**

Header	Command	ID	Data Length	Sub Cmd	Check Sum
0xAA	0x50		0x01	0x00	

- **Set**

Not Supported

- **Ack**

Header	Command	ID	Data Length	Ack	r-CMD	Sub CMD	Data 1
0xAA	0xFF		0x05	'A'	0x50	0x00	Data H
Data 2	Check Sum						
Data L							

Data H/L : Light Sensor lux data

- **Nak**

Header	Command	ID	Data Length	Nak	r-CMD	r-Sub Cmd	Val1
0xAA	0xFF		0x04	'N'	0x50	0x00	ERR
Check Sum							

ERR : Error code that shows what occurred error is

2.1.50.01 HeatEx Temperature

- **Function**

Get the heat exchanger temperature of the device

Note : Depends on each model spec it will be supported or not

- **Get**

Header	Command	ID	Data Length	Sub Cmd	Check Sum
0xAA	0x50		0x01	0x01	

- **Set**

Not Supported

- **Ack**

Command	ID	Data Length	Ack	r-CMD	Sub CMD	Data1	Check Sum
0xFF		0x04	'A'	0x50	0x01	Temperature	

Temperature : heat exchanger temperature -60~125 (°C)

Note : Actual temperature range will be differ by each product spec

- **Nak**

Header	Command	ID	Data Length	Nak	r-CMD	r-Sub Cmd	Val1
0xAA	0xFF		0x04	'N'	0x50	0x01	ERR
Check Sum							

ERR : Error code that shows what occurred error is

2.1.50.02 LED Plate Temperature

- **Function**

Get the LED plate temperature of the device

Note : Depends on each model spec it will be supported or not

- **Get**

Header	Command	ID	Data Length	Sub Cmd	Check Sum
0xAA	0x50		0x01	0x02	

- **Set**

Not Supported

- **Ack**

Command	ID	Data Length	Ack	r-CMD	Sub CMD	Data1	Check Sum
0xFF		0x04	'A'	0x50	0x02	Temperature	

Temperature : LED plate temperature -60~125 (°C)

Note : Actual temperature range will be differ by each product spec

- **Nak**

Header	Command	ID	Data Length	Nak	r-CMD	r-Sub Cmd	Val1
0xAA	0xFF		0x04	'N'	0x50	0x02	ERR
Check Sum							

ERR : Error code that shows what occurred error is

2.1.50.03 Final Duty

- **Function**

Get the final duty of the device.

Note : Depends on each model spec it will be supported or not

Final duty is a calculated value based on luminance and other picture related factor

- **Get**

Header	Command	ID	Data Length	Sub Cmd	Check Sum
0xAA	0x50		0x01	0x03	

- **Set**

Not Supported

- **Ack**

Header	Command	ID	Data Length	Ack	r-CMD	Sub CMD	Val1
0xAA	0xFF		0x05	'A'	0x50	0x03	Final Duty Data1
Val2	Check Sum						
Final Duty Data2							

Final Duty Data : Current final duty data (0~1023)

- **Nak**

Header	Command	ID	Data Length	Nak	r-CMD	r-Sub Cmd	Val1
0xAA	0xFF		0x04	'N'	0x50	0x03	ERR
Check Sum							

ERR : Error code that shows what occurred error is

2.1.51 EQ 100Hz Control

- **Function**

Control the device sound 100Hz range equalizer to customize the volume and pitch and enhance the richness of the sound output

- **Get**

Header	Command	ID	Data Length	Check Sum
0xAA	0x51		0	

- **Set**

Header	Command	ID	Data Length	Data 1	Check Sum
0xAA	0x51		0x01	100Hz Equalizer	

100Hz Equalizer : 100Hz feild data among Equalizer set up in TV/Monitor (0~20)

Note : menu 0 value is 0x0a, menu -10 is 0x00

- **Ack**

Header	Command	ID	Data Length	Ack/Nak	r-CMD	Val 1	Check Sum
0xAA	0xFF		0x03	'A'	0x51	100Hz Equalizer	

100Hz : Same as above

- **Nak**

Header	Command	ID	Data Length	Ack/Nak	r-CMD	Val 1	Check Sum
0xAA	0xFF		0x03	'N'	0x51	100Hz Equalizer	

ERR : Error code that shows what occurred error is

2.1.52 EQ 300Hz Control

- **Function**

Control the device sound 300Hz range equalizer to customize the volume and pitch and enhance the richness of the sound output

- **Get**

Header	Command	ID	Data Length	Check Sum
0xAA	0x52		0x00	

- **Set**

Header	Command	ID	Data Length	Data 1	Check Sum
0xAA	0x52		0x01	300Hz Equalizer	

300Hz Equalizer : 300Hz feild data among Equalizer set up in TV/Monitor (0~20)

Note : menu 0 value is 0x0a, menu -10 is 0x00

- **Ack**

Header	Command	ID	Data Length	Ack/Nak	r-CMD	Val 1	Check Sum
0xAA	0xFF		0x03	'A'	0x52	300Hz Equalizer	

300Hz Equalizer : Same as above

- **Nak**

Header	Command	ID	Data Length	Ack/Nak	r-CMD	Val 1	Check Sum
0xAA	0xFF		0x03	'N'	0x52	ERR	

ERR : Error code that shows what occurred error is

2.1.53 EQ 1kHz Control

- **Function**

Control the device sound 1KHz range equalizer to customize the volume and pitch and enhance the richness of the sound output

- **Get**

Header	Command	ID	Data Length	Check Sum
0xAA	0x53		0x00	

- **Set**

Header	Command	ID	Data Length	Data 1	Check Sum
0xAA	0x53		0x01	1kHz Equalizer	

1kHz Equalizer : 1KHz feild data among Equalizer set up in TV/Monitor (0~20)

Note : menu 0 value is 0x0a, menu -10 is 0x00

- **Ack**

Header	Command	ID	Data Length	Ack/Nak	r-CMD	Val 1	Check Sum
0xAA	0xFF		0x03	'A'	0x53	1kHz Equalizer	

1kHz Equalizer : Same as above

- **Nak**

Header	Command	ID	Data Length	Ack/Nak	r-CMD	Val 1	Check Sum
0xAA	0xFF		0x03	'N'	0x53	ERR	

ERR : Error code that shows what occurred error is

2.1.54 EQ 3kHz Control

- **Fuction**

Control the device sound 3KHz range equalizer to customize the volume and pitch and enhance the richness of the sound output

- **Get**

Header	Command	ID	Data Length	Check Sum
0xAA	0x54		0x00	

- **Set**

Header	Command	ID	Data Length	Data 1	Check Sum
0xAA	0x54		0x01	3kHz Equalizer	

3kHz Equalizer : 3KHz feild data among Equalizer set up in TV/Monitor (0~20)

Note : menu 0 value is 0x0a, menu -10 is 0x00

- **Ack**

Header	Command	ID	Data Length	Ack/Nak	r-CMD	Val 1	Check Sum
0xAA	0xFF		0x03	'A'	0x54	3kHz Equalizer	

3kHz Equalizer : Same as above

- **Nak**

Header	Command	ID	Data Length	Ack/Nak	r-CMD	Val 1	Check Sum
0xAA	0xFF		0x03	'N'	0x54	ERR	

ERR : Error code that shows what occurred error is

2.1.55 EQ 10kHz Control

- **Function**

Control the device sound 10KHz range equalizer to customize the volume and pitch and enhance the richness of the sound output

- **Get**

Header	Command	ID	Data Length	Check Sum
0xAA	0x55		0x00	

- **Set**

Header	Command	ID	Data Length	Data 1	Check Sum
0xAA	0x55		0x01	10kHz Equalizer	

10kHz Equalizer : 10KHz feild data among Equalizer set up in TV/Monitor (0~20)

Note : menu 0 value is 0x0a, menu -10 is 0x00

- **Ack**

Header	Command	ID	Data Length	Ack/Nak	r-CMD	Val 1	Check Sum
0xAA	0xFF		0x03	'A'	0x55	10kHz Equalizer	

10kHz Equalizer : Same as above

- **Nak**

Header	Command	ID	Data Length	Ack/Nak	r-CMD	Val 1	Check Sum
0xAA	0xFF		0x03	'N'	0x55	ERR	

ERR : Error code that shows what occurred error is

2.1.56 Energy Saving_LFD

- **Function**

Control the device energy saving mode

Note : Based on the product spec this command control the Max Power Saving on the menu

- **Get**

Header	Command	ID	Data Length	Check Sum
0xAA	0x56		0x00	

- **Set**

Header	Command	ID	Data Length	Data 1	Check Sum
0xAA	0x56		0x01	Energy Saving	

Energy Saving : Energy saving mode value to set to signage device

0x00	Energy Saving Off	0x01	Energy Saving On
------	-------------------	------	------------------

- **Ack**

Header	Command	ID	Data Length	Ack/Nak	r-CMD	Val 1	Check Sum
0xAA	0xFF		0x03	'A'	0x56	Energy Saving	

Energy Saving : Same as above

- **Nak**

Header	Command	ID	Data Length	Ack/Nak	r-CMD	Val 1	Check Sum
0xAA	0xFF		0x03	'N'	0x56	ERR	

ERR : Error code that shows what occurred error is

2.1.57 Auto Lamp Control

- **Function**

Control the device lamp schedule

Note :When Manual Lamp Control is on, Auto Lamp Control will automatically turn off.

- **Get**

Header	Command	ID	Data Length	Check Sum
0xAA	0x57		0x00	

- **Set**

Header	Command	ID	Data Length	Data 1	Data 2	Data 3	Data 4
0xAA	0x57		0x08	Lmax_H	Lmax_M	Lmax_AP	LmaxValue
Data 5	Data 6	Data 7	Data 8	Check Sum			
Lmin_H	Lmin_M	Lmin_AP	LminValue				

Lmax_H : Auto Lamp Max Time Hour set on TV/Monitor (1 ~ 12)

Lmax_M : Auto Lamp Max Time Minute set on TV/Monitor (0 ~ 59)

Lmax_AP : Auto Lamp Max Time set on TV/Monitor AM/PM (AM :1 / PM:0)

LmaxValue : Auto Lamp Max Value set on TV/Monitor (0 ~ 100)

Lmin_H : Auto Lamp Min Time Hour set on TV/Monitor (1 ~ 12)

Lmin_M : Auto Lamp Min Time Minute set on TV/Monitor (0 ~ 59)

Lmin_AP : Auto Lamp Min Time set on TV/Monitor AM/PM (AM :1 / PM:0)

LminValue : Auto Lamp Min Value set on TV/Monitor (0 ~ 100)

Note : When LminValue is returned to 0xFF, Auto Lamp Control is off.

When Dynamic contrast is On, Auto Lamp Control does not operate.

- **Ack**

Header	Command	ID	Data Length	Ack/Nak	r-CMD	Val 1	Val 2
0xAA	0xFF		0x0A	'A'	0x57	Lmax_H	Lmax_M
Val 3	Val 4	Val 5	Val 6	Val 7	Val 8	Check Sum	
Lmax_AP	LmaxValue	Lmin_H	Lmin_M	Lmin_AP	LminValue		

Lmax_H, Lmax_M, Lmax_AP, LmaxValue, Lmin_H, Lmin_M, Lmin_AP, LminValue : Same as above

- **Nak**

Header	Command	ID	Data Length	Ack/Nak	r-CMD	Val 1	Check Sum
0xAA	0xFF		3	'N'	0x57	ERR	

ERR : Error code that shows what occurred error is

2.1.58 Manual Lamp Control

- **Function**

Control the device lamp(backlight)

Note : When Auto Lamp Control is on, lamp value can be changed based on lamp schedule setting.

- **Get**

Header	Command	ID	Data Length	Check Sum
0xAA	0x58		0x00	

- **Set**

Header	Command	ID	Data Length	Data 1	Check Sum
0xAA	0x58		0x01	LampValue	

LampValue : Manual Lamp value to be set on TV/Monitor (0 ~ 100)

- **Ack**

Header	Command	ID	Data Length	Ack/Nak	r-CMD	Val 1	Check Sum
0xAA	0xFF		0x03	'A'	0x58	LampValue	

LampValue : Same as above

Note : When LampValue is returned as 0xFF, that means gotten value is invalid.
When Dynamic contrast is on, Manual Lamp Control does not operate.

- **Nak**

Header	Command	ID	Data Length	Ack/Nak	r-CMD	Val 1	Check Sum
0xAA	0xFF		0x03	'N'	0x58	ERR	

ERR : Error code that shows what occurred error is

2.1.59 Safety Screen Run Control

- **Function**

Control the device immediate safety screen run mode

Note : Safety screen will work immediately regardless timer mode

- **Get**

Header	Command	ID	Data Length	Check Sum
0xAA	0x59		0x00	

- **Set**

Header	Command	ID	Data Length	Data 1	Check Sum
0xAA	0x59		0x01	Safety Screen Type	

Safety Screen Type : Safety Screen Type to be set on TV/Monitor (1~6)

0x00	Off
0x01	Signal Pattern
0x02	All White
0x03	Scroll
0x04	Bar
0x06	Eraser
0x07	Pixel
...	
0x10	Rolling Bar
0x11	Fading Screen

Note : 1(0x01), 2(0x02) only works with PDP models

- **Ack**

Header	Command	ID	Data Length	Ack/Nak	r-CMD	Val 1	Check Sum
0xAA	0xFF		0x03	'A'	0x59	Safety Screen Type	

Safety Screen Type : Same as above

- **Nak**

Header	Command	ID	Data Length	Ack/Nak	r-CMD	Val 1	Check Sum
0xAA	0xFF		0x03	'N'	0x59	ERR	

ERR : Error code that shows what occurred error is

2.1.5A Inverse Control

- **Function**

Control the device inverter

Note : Depends on the product spec, it will work as panel control
 Similar command is exist on 0xf9

- **Get**

Header	Command	ID	Data Length	Check Sum
0xAA	0x5A		0x00	

- **Set**

Header	Command	ID	Data Length	Data 1	Check Sum
0xAA	0x5A		0x01	Inverse	

Inverse : Inverse On/Off Code to be set on TV/Monitor

0x00	OFF	0x01	ON
------	-----	------	----

- **Ack**

Header	Command	ID	Data Length	Ack/Nak	r-CMD	Val 1	Check Sum
0xAA	0xFF		0x03	'A'	0x5A	Inverse	

Inverse : Same as above

- **Nak**

Header	Command	ID	Data Length	Ack/Nak	r-CMD	Val 1	Check Sum
0xAA	0xFF		0x03	'N'	0x5A	ERR	

ERR : Error code that shows what occurred error is

2.1.5B Safety Screen Control

● Function

Control the device safety screen timer

● Get

Header	Command	ID	Data Length	Check Sum
0xAA	0x5B		0x00	

● Set

[Mode 1] When the Timer is Repeat

Header	Command	ID	Data Length	Data 1	Data 2	Data 3	Check Sum
0xAA	0x5B		0x03	Type	T.Period	T.Time	

[Mode 2] When the Timer is Interval

Header	Command	ID	Data Length	Data 1	Data 2	Data 3	Data 4
0xAA	0x5B		0x07	Type	StartTime-Hour	StartTime-Min.	StartTime-am/pm
Data 5	Data 6	Data 7	Check Sum				
EndTime-Hour	EndTime-Min.	EndTime-am/pm					

Type :Timer type to set Device

Timer Type	Data for Repeat	Data for Interval
OFF	0x00	0x00
Scroll	0x03	0x83
Pixel	0x04	0x84
Bar	0x05	0x85
Eraser	0x06	0x86
All White	0x09	0x89
Pattern	0x0A	0x8A
Rolling Bar	0x10	0x90
Fading Screen	0x11	0x91

Note :

- If the value is 0x00, means timer is off.(It doesn't matter the length 3/7)
- If the value is not 0x00 and the MSB is 00 means timer type is Repeat and the MSB is 1 means timer type is interval
- All White, Pattern are only work with PDP model

T.Period : Timer periode hour data to set Device (1 ~ 10 Hr.)

T.Time :Timer periode code to set Device (10 ~ 50 sec.)

0x01	10 sec
0x02	20 sec
0x03	30 sec
0x04	40 sec
0x05	50 sec

Note : If the timer type is Rolling Bar or Fading Screen, timer will work only 1 cycle regardless it's type

If the timer periode is 0 or timer time is 0, timer will turn off
 (IF the timer type is Rolling Bar or Fading Scree it will not turns off)

- Start Time-Hour** : The value of Start Time Hour (1 ~ 12)
- Start Time-Min** : The value of Start Time Minute (0 ~ 59)
- Start Time-am/pm** : The value of Start Time AM/PM (1 : AM, 0 : PM)
- End Time-Hour** : The value of End Time Hour (1 ~ 12)
- End Time-Min** : The value of End Time Minute (0 ~ 59)
- End Time-am/pm** : The value of End Time AM/PM (1 : AM, 0 : PM)

● **Ack**

[Mode 1] When the Timer is Repeat

Header	Command	ID	Data Length	Ack/Nak	r-CMD	Val 1	Val 2
0xAA	0xFF		ID	0x05	'A'	0x5B	Type
Val 3	Check Sum						
T.Time							

Type, T.Period, T.Time : Same as above

[Mode 2] When the Timer is Interval

Header	Command	ID	Data Length	Ack/Nak	r-CMD	Val 1	Val 2
0xAA	0xFF		ID	0x09	'A'	0x5B	Type
Val 3	Val 4	Val 6		Val 7	Check Sum		
StartTime-Min	StartTime-am/pm	End Time-Hour	End Time-Min	End Time-am/pm			

Type, StartTime-Hour, StartTime-Min, StartTime-am/pm, End Time-Hour, End Time-Min, End Time-am/pm : Same as above

● **Nak**

Header	Command	ID	Data Length	Ack/Nak	r-CMD	Val 1	Check Sum
0xAA	0xFF		ID	0x03	'N'	0x5B	

ERR : The error code indicating which error occurred.

2.1.5C Video Wall Mode Control

- **Function**

Control the device video wall mode

Note : It will work when the video wall is on. And it will not work on MagicNet

- **Get**

Header	Command	ID	Data Length	Check Sum
0xAA	0x5C		0x00	

- **Set**

Header	Command	ID	Data Length	Data 1	Check Sum
0xAA	0x5C		0x01	WallMode	

WallMode : Video Wall Mode code to be set on TV/Monitor

0x00	Natural	0x01	Full
------	---------	------	------

- **Ack**

Header	Command	ID	Data Length	Ack/Nak	r-CMD	Val 1	Check Sum
0xAA	0xFF		0x03	'A'	0x5C	WallMode	

WallMode : same as above

- **Nak**

Header	Command	ID	Data Length	Ack/Nak	r-CMD	Val 1	Check Sum
0xAA	0xFF		0x03	'N'	0x5C	ERR	

ERR : Error code that shows what occurred error is

2.1.5D Safety Lock

- **Function**

Control the device safety lock mode

Note : Can operate regardless of whether power is on/off.

- **Get**

Header	Command	ID	Data Length	Check Sum
0xAA	0x5D		0x00	

- **Set**

Header	Command	ID	Data Length	Data 1	Check Sum
0xAA	0x5D		0x01	Lock	

Lock : Lock code to be set on TV/Monitor

0x00	Off	0x01	On
------	-----	------	----

- **Ack**

Header	Command	ID	Data Length	Ack/Nak	r-CMD	Val 1	Check Sum
0xAA	0xFF		0x03	'A'	0x5D	Lock	

Lock : Same as above

- **Nak**

Header	Command	ID	Data Length	Ack/Nak	r-CMD	Val 1	Check Sum
0xAA	0xFF		0x03	'N'	0x5D	ERR	

ERR : Error code that shows what occurred error is

2.1.5F Panel Lock

- **Function**

Control the device panel key lock mode

Note : Can operate regardless of whether power is on/off.

- **Get**

Header	Command	ID	Data Length	Check Sum
0xAA	0x5F		0x00	

- **Set**

Header	Command	ID	Data Length	Data 1	Check Sum
0xAA	0x5F		0x01	Button Lock	

Button Lock : Panel Key Lock On/Off code to be set on TV/Monitor

0x00	Unlock	0x01	Lock
------	--------	------	------

- **Ack**

Header	Command	ID	Data Length	Ack/Nak	r-CMD	Val 1	Check Sum
0xAA	0xFF		0x03	'A'	0x5F	Button Lock	

Button Lock : Same as above

- **Nak**

Header	Command	ID	Data Length	Ack/Nak	r-CMD	Val 1	Check Sum
0xAA	0xFF		0x03	'N'	0x5F	ERR	

ERR : Error code that shows what occurred error is

2.1.61 Channel Up/Down

- **Function**

Up/Down the device channel of TV source

Note : If PIP is on and pip source is TV, it also should work.
Only works with models include TV.

- **Get**

Not Support

- **Set**

Header	Command	ID	Data Length	Data 1	Check Sum
0xAA	0x61		0x01	Channel Up/Down	

Channel Up/Down: Channel UP or Down to be set on Device (0~1)

0x00	Up	0x01	Down
------	----	------	------

- **Ack**

Header	Command	ID	Data Length	Ack/Nak	r-CMD	Val 1	Check Sum
0xAA	0xFF		0x03	'A'	0x61	Channel Up/Down	

Channel Up/Down : Same as above

- **Nak**

Header	Command	ID	Data Length	Ack/Nak	r-CMD	Val 1	Check Sum
0xAA	0xFF		0x03	'N'	0x61	ERR	

ERR : Error code that shows what occurred error is

2.1.62 Volume Up/Down

- **Function**

Up/Down the device sound volume

- **Get**

Not Support

- **Set**

Header	Command	ID	Data Length	Data 1	Check Sum
0xAA	0x62		0x01	Volume Up/Down	

Volume Up/Down : Volume UP or Down to be set on Device (0 ~ 100)

0x00	Up	0x01	Down
------	----	------	------

- **Ack**

Header	Command	ID	Data Length	Ack/Nak	r-CMD	Val 1	Check Sum
0xAA	0xFF		0x03	'A'	0x62	Volume Up/Down	

Volume Up/Down : Same as above

- **Nak**

Header	Command	ID	Data Length	Ack/Nak	r-CMD	Val 1	Check Sum
0xAA	0xFF		0x03	'N'	0x62	ERR	

ERR : Error Code showing what occurred error is.

2.1.63 Ticker

- **Function**

Control the device ticker related things

- **Get**

Header	Command	ID	Data Length	Check Sum
0xAA	0x63		0x00	

- **Set**

Header	Command	ID	Data Length	Data 1	Data 2	Data 3	Data 4
0xAA	0x63		Length	Ticker On/Off	Start Hour	Start Minute	Start AM/PM
Data 5	Data 6	Data 7	Data 8	Data 9	Data 10	Data 11	Data 12
End Hour	End Minute	End AM/PM	Position Horizontal	Position Vertical	Motion On/Off	Motion Direction	Motion Speed
Data 13	Data 14	Data 15	Data 16	Data 17	Data 18	Data 19	Data 20
Font Size	Foreground Color	Background Color	Foreground Opacity	Background Opacity	Message Date 1	Message Date 2	Message Date 3
Data 21	Data 22	Data N	Check Sum				
Message Date 4	...	Message Date N					

Note : Based on the product spec, each option will work or not

Length : It means the variable length of data that is going to be sent.

You can set it differently depending on the length of message data and you need to input messages according to length that already set.

Ticker On/Off :Ticker's On/Off Code that is going to be set in Device(0 ~ 1)

0x00	Ticker Off	0x01	Ticker On
------	------------	------	-----------

Start Hour : The value of Start Time Hour that operate Ticker in Device (1 ~ 12)

Strat Minute : The value of Start Time Minute that operate Ticker in Device (0 ~ 59)

Start AM/PM : Start Time AM/PM that operate Ticker in Device(0 ~ 1)

0x00	PM	0x01	AM
------	----	------	----

End Hour : The value of End Time Hour that operate Ticker in Device(1 ~ 12)

End Minute : The value of End Time Minute that operate Ticker in Device (0 ~ 59)

End AM/PM : End Time AM/PM that operate Ticker in Device(0 ~ 1)

0x00	PM	0x01	AM
------	----	------	----

Position Horizontal : Value of horizontal position of message that is presented in Device (0 ~ 2)

Position Vertical : The value of vertical position of message that is presented in Device (0 ~ 2)

Position Horizontal		Position Vertical	
0x00	Center	0x00	Middle
0x01	Left	0x01	Top
0x02	Right	0x02	Bottom

Motion On/Off : On/Off Code of Motion that is set in Device (0 ~ 1)

0x00	Motion Off	0x01	Motion On
------	------------	------	-----------

Motion Direction : The direction which motion that is set in Device moves (0 ~ 3)

0x00	Left
------	------

0x01	Right
0x02	Up
0x03	Down

Motion Speed : The speed which motion that is set in Device moves (0 ~ 2)

Font Size : The font size of message that is set in Device (0 ~ 2)

Motion Speed		Font Size	
Normal	0x00	Standard	0x00
Slow	0x01	Small	0x01
Fast	0x02	Large	0x02

Foreground Color : Foreground Color of message that is set in Device (0 ~ 7)

Background Color : Background Color of message that is set in Device (0 ~ 7)

Foreground Color		Background Color	
0x00	Black	0x00	Black
0x01	White	0x01	White
0x02	Red	0x02	Red
0x03	Green	0x03	Green
0x04	Blue	0x04	Blue
0x05	Yellow	0x05	Yellow
0x06	Magenta	0x06	Magenta
0x07	Cyan	0x07	Cyan

Foreground Opacity : Foreground Opacity of message that is set in Device (0 ~ 3)

Background Opacity : Background Opacity of message that is set in Device (0 ~ 3)

Foreground Opacity		Background Opacity	
0x03	Flashing	0x00	Solid
0x04	Flash All	0x01	Transparent
0x05	Off	0x02	Translucent

Message Data : Enter Ticker Message that is displayed in Device.

It is sent as hexadecimal value of message and it can be entered up to 232 bytes

Ex) Hello => 0x48 0x65 0x6C 0x6C 0x6F

Note : Based on the product spec, it is supported multi lingual with UTF8 format and more than 25 characters

Font Style Reset : If font size reset is chosen in MDC Application, all values from Data 13 to Data 17 will be 0x00 and Set command is sent to get Default value.

● **Ack**

Header	Command	ID	Data Length	Ack/Nak	r-CMD	Val 1	Val 2
0xAA	0xFF		Length	'A'	0x63	Ticker On/Off	Start Hour
Val 3	Val 4	Val 5	Val 6	Val 7	Val 8	Val 9	Val 10
Start Minute	Start AM/PM	End Hour	End Minute	End AM/PM	Position Horizontal	Position Vertical	Motion On/Off
Val 11	Val 12	Val 13	Val 14	Val 15	Val 16	Val 17	Val 18
Motion	Motion	Font Size	Foreground	Background	Foreground	Background	Message

Direction	Speed		Color	Color	Opacity	Opacity	Date 1
Val 19	Val 20	Val 21	Val 22	Val N	Check Sum		
Message Date 2	Message Date 3	Message Date N			

Val1 ~ ValN : Same as above

- Nak

Header	Command	ID	Data Length	Ack/Nak	r-CMD	Val 1	Check Sum
0xAA	0xFF		0x03	'N'	0x63	ERR	

ERR : Error Code showing what occurred error is.

2.1.65 Sound Select Control

- **Function**

Control the device sound source as main or PIP

Note : Same function is also exist on 0x47

- **Get**

Header	Command	ID	Data Length	Check Sum
0xAA	0x65		0x00	

- **Set**

Header	Command	ID	Data Length	Data 1	Check Sum
0xAA	0x65		0x01	S.Select	

S.Select: The Sound Select code to set for the TV or monitor

0x00	Sub	0x01	Main
------	-----	------	------

- **Ack**

Header	Command	ID	Data Length	Ack/Nak	r-CMD	Val 1	Check Sum
0xAA	0xFF		0x03	'A'	0x65	S.Select	

S.Select: Same as above.

- **Nak**

Header	Command	ID	Data Length	Ack/Nak	r-CMD	Val 1	Check Sum
0xAA	0xFF		0x03	'N'	0x65	ERR	

ERR: The error code indicating which error occurred.

2.1.66 PC Module Detect

- **Function**

Get the module which is connected to device

- **Get**

Header	Command	ID	Data Length	Check Sum
0xAA	0x66		0x00	

- **Set**

Not Support

- **Ack**

Header	Command	ID	Data Length	Ack/Nak	r-CMD	Val 1	Check Sum
0xAA	0xFF		0x03	'A'	0x66	Detection Source	

Detection Source : Information of detected Source

0x00	Not Detected
0x01	MagicInfo
0x02	Plug In Module

- **Nak**

Header	Command	ID	Data Length	Ack/Nak	r-CMD	Val 1	Check Sum
0xAA	0xFF		0x03	'N'	0x66	ERR	

ERR : Error Code showing what occurred error is.

2.1.67 Device Name

- **Function**

Control the device name which is shown on Magicinfo server

- **Get**

Header	Command	ID	Data Length	Check Sum
0xAA	0x67		0x00	

- **Set**

Header	Command	ID	Data Length	Data 1	...	Data N	Check Sum
0xAA	0x67		Length	Device Name			

Length : It means the variable length of data transmitted.

It can be answered differently depending on the length of message data and the maximum length of device name is 15.

Device Name : It shows the information about entered device name.

Note : Depends on the product spec set will work

- **Ack**

Header	Command	ID	Data Length	Ack/Nak	r-CMD	Val 1	...
0xAA	0xFF		Length	'A'	0x67	Device Name Data1	...
Val N	Check Sum						
Device Name Data N							

Length, Device Name : Same as above

- **Nak**

Header	Command	ID	Data Length	Ack/Nak	r-CMD	Val 1	Check Sum
0xAA	0xFF		0x03	'N'	0x67	ERR	

ERR : Error Code showing what occurred error is.

2.1.68 Speaker Select

- **Function**

Control the device sound out speaker

- **Get**

Header	Command	ID	Data Length	Check Sum
0xAA	0x68		0x00	

- **Set**

Header	Command	ID	Data Length	Data 1	Check Sum
0xAA	0x68		0x01	S.Select	

S.Select : Speaker Select Code that is going to be set in Device

0x00	Internal	0x01	External
------	----------	------	----------

- **Ack**

Header	Command	ID	Data Length	Ack/Nak	r-CMD	Val 1	Check Sum
0xAA	0x68		0x03	'A'	0x68	S.Select	

S.Select : Same as above

- **Nak**

Header	Command	ID	Data Length	Ack/Nak	r-CMD	Val 1	Check Sum
0xAA	0xFF		0x03	'N'	0x68	ERR	

ERR : Error Code showing what occurred error is.

2.1.70 OSD On/Off

- **Function**

Control the device OSD

- **Note :**

1. In case OSD on Set display OSD on it's screen and in the case off there will be no OSD
2. Depends on the product spec, it will be work as multiple types message display control

- **Get**

Header	Command	ID	Data Length	Check Sum
0xAA	0x70		0x00	

- **Set**

Header	Command	ID	Data Length	Data 1	Check Sum
0xAA	0x70		0x01	OSD	

OSD : OSD code to set Device

0x00	OSD Off	0x01	OSD On
------	---------	------	--------

- **Ack**

Header	Command	ID	Data Length	Ack/Nak	r-CMD	Val 1	Check Sum
0xAA	0xFF		0x03	'A'	0x70	OSD	

OSD : Same as above

Note : Depends on HongKong airport protocol option, ACK/NAK will returned in opposite way

- **Nak**

Header	Command	ID	Data Length	Ack/Nak	r-CMD	Val 1	Check Sum
0xAA	0xFF		0x03	'N'	0x70	ERR	

ERR : Error Code showing what occurred error is.

2.1.71 P.Mode Control

- **Function**

Control the device picture mode

- **Get**

Header	Command	ID	Data Length	Check Sum
0xAA	0x71		0x00	

Note : Depends on the product spec get will not supported

Depends on the product spec it can be work as control the picture related items (like brightness, contrast ...)

- **Set**

Header	Command	ID	Data Length	Data 1	Check Sum
0xAA	0x71		0x01	Pmode	

Pmode : Picture mode to set MFM/LFD

[Source Base working model]

Source : AV, S-Video, Component, HDCP (TV)		Source : PC, BNC, DVI, DisplayPort (MagicNet)	
Data	Mode	Data	Mode
0x00	Dynamic	0x10	Entertain
0x01	Standard	0x11	Internet
0x02	Movie	0x12	Text
0x03	Custom	0x13	Custom
0x04	Natural	0x14	Advertisement
0x05	Calibration	0x15	Information
0x50	Off	0x16	Calibration
		0x50	Off

[Commonly working model]

Data	Mode	Data	Mode
0x00	Dynamic	0x01	Live
0x02	Movie	-	-
0x04	Natural	-	-
0x16	Calibration	-	-
0x20	Shop & Mall - Video	0x21	Shop & Mall - Text
0x22	Office & School - Video	0x23	Office & School - Text
0x24	Terminal & Station - Video	0x25	Terminal & Station - Text
0x26	Videowall - Video	0x27	Videowall - Text
0x30	HDR+(get only)	-	-
0x90	Reserved(for other purpose)	-	-

Note :

- Depends on each model spec it will support the picture mode : 0x16 and 0x20~0x27 only

- **Ack**

Header	Command	ID	Data Length	Ack/Nak	r-CMD	Val 1	Check Sum
0xAA	0xFF		0x03	'A'	0x71	Pmode	

Pmode : 상동

- Nak

Header	Command	ID	Data Length	Ack/Nak	r-CMD	Val 1	Check Sum
0xAA	0xFF		0x03	'N'	0x71	ERR	

ERR : The error code indicating which error occurred.

2.1.72 S.Mode Control

- **Function**

Control the device sound mode

- **Get**

Header	Command	ID	Data Length	Check Sum
0xAA	0x72		0x00	

- **Set**

Header	Command	ID	Data Length	Data 1	Check Sum
0xAA	0x72		0x01	Smode	

Smode : Sound Mode Code

0x00	Standard
0x01	Music
0x02	Movie
0x03	Speech
0x04	Custom
0x05	Amplify
0x06	Optimized

- **Ack**

Header	Command	ID	Data Length	Ack/Nak	r-CMD	Val 1	Check Sum
0xAA	0xFF		0x03	'A'	0x72	Smode	

Smode : Same as above

- **Nak**

Header	Command	ID	Data Length	Ack/Nak	r-CMD	Val 1	Check Sum
0xAA	0xFF		0x03	'N'	0x72	ERR	

ERR : Error Code showing what occurred error is.

2.1.73 Digital NR Control

● Function

Control the device digital noise reduction mode.

Note :

1. AV, S-Video, Component, DVI(HDCP) Only
2. A product which has **** Text , **** Video/Image and Calibration as picture mode, it will not affect by the 1st condition and instead,
 - It will work in case of PIC_MODE is PIC_MODE_VIDEO
 - * For the PIC_MODE definition pls refer AnnexB
3. It will work as Digital Clean View in the menu depends on each model spec

● Get

Header	Command	ID	Data Length	Check Sum
0xAA	0x73		0x00	

● Set

Header	Command	ID	Data Length	Data 1	Check Sum
0xAA	0x73		0x01	NR Mode	

NR Mode : NR Mode On/Off code to set in Device

0x00	NR Mode Off
0x01	NR Mode Low(On)
0x02	NR Mode Medium
0x03	NR Mode High
0x04	NR Mode Auto
0x05	NR Mode Auto Visualization

● Ack

Header	Command	ID	Data Length	Ack/Nak	r-CMD	Val 1	Check Sum
0xAA	0xFF		0x03	'A'	0x73	NR Mode	

NR Mode : Same as above

● Nak

Header	Command	ID	Data Length	Ack/Nak	r-CMD	Val 1	Check Sum
0xAA	0xFF		0x03	'N'	0x73	ERR	

ERR : Error Code showing what occurred error is.

2.1.75 PC Color Tone Control

● Function

Control the device color tone

Note :

1. PC, BNC, DVI Only
2. A product which has **** Text , **** Video/Image and Calibration as picture mode, it will not be affected by the 1st condition and instead, it will work with **** Text of picture mode in the menu
3. Similar command exists on 0x3E Color Tone Control

● Get

Header	Command	ID	Data Length	Check Sum
0xAA	0x75		0x00	

● Set

Header	Command	ID	Data Length	Data 1	Check Sum
0xAA	0x75		0x01	Color Tone	

Color Tone : Color Tone value code to set on TV/Monitor (0 ~ 3)

0x00	Custom	0x01	Cool
0x02	Normal	0x03	Warm
-	-	0x05	Natural
0x50	Off	-	-

● Ack

Header	Command	ID	Data Length	Ack/Nak	r-CMD	Val 1	Check Sum
0xAA	0xFF		0x03	'A'	0x75	Color Tone	

Color Tone : Same as above

● Nak

Header	Command	ID	Data Length	Ack/Nak	r-CMD	Val 1	Check Sum
0xAA	0xFF		0x03	'N'	0x75	ERR	

ERR : Error code that shows what occurred error is

2.1.76 Auto AutoAdjustment

- **Function**

Control the device auto adjustment mode

Note : If this value is Disable. Then Auto Adjustment is not work.

- **Get**

Header	Command	ID	Data Length	Check Sum
0xAA	0x76		0x00	

- **Set**

Header	Command	ID	Data Length	Data 1	Check Sum
0xAA	0x76		0x01	A.Adjustment	

A. Adjustment : Auto Auto Adjustment Enable/Disable Value Code to be set on TV/Monitor

0x00	Disable	0x01	Enable
------	---------	------	--------

- **Ack**

Header	Command	ID	Data Length	Ack/Nak	r-CMD	Val 1	Check Sum
0xAA	0xFF		0x03	'A'	0x76	A.Adjustment	

A.Adjustment : Same as above

- **Nak**

Header	Command	ID	Data Length	Ack/Nak	r-CMD	Val 1	Check Sum
0xAA	0xFF		0x03	'N'	0x76	ERR	

ERR : Error code that shows what occurred error is

2.1.77 All Keys Lock

- **Function**

Control the device remote lock and button lock

Note : Can operate regardless of whether power is on/off.

- **Get**

Header	Command	ID	Data Length	Check Sum
0xAA	0x77		0x00	

- **Set**

Header	Command	ID	Data Length	Data 1	Check Sum
0xAA	0x77		0x01	AKL	

All Key : Lock On/Off code of every Key to be set on TV/Monitor

0x00	OFF	0x01	ON
------	-----	------	----

- **Ack**

Header	Command	ID	Data Length	Ack/Nak	r-CMD	Val 1	Check Sum
0xAA	0xFF		0x03	'A'	0x77	AKL	

All Key : Same as above

- **Nak**

Header	Command	ID	Data Length	Ack/Nak	r-CMD	Val 1	Check Sum
0xAA	0xFF		0x03	'N'	0x77	ERR	

ERR : Error code that shows what occurred error is

2.1.78 SRS TSXT Control

- **Function**

Control the device sound SRS TS XT mode

- **Get**

Header	Command	ID	Data Length	Check Sum
0xAA	0x78		0x00	

- **Set**

Header	Command	ID	Data Length	Data 1	Check Sum
0xAA	0x78		0x01	SRS	

SRS : SRS TS XT code to be set on TV/Monitor

0x00	SRS OFF	0x01	SRS ON
------	---------	------	--------

- **Ack**

Header	Command	ID	Data Length	Ack/Nak	r-CMD	Val 1	Check Sum
0xAA	0xFF		0x03	'A'	0x78	SRS	

SRS : Same as above

- **Nak**

Header	Command	ID	Data Length	Ack/Nak	r-CMD	Val 1	Check Sum
0xAA	0xFF		0x03	'N'	0x78	ERR	

ERR : Error code that shows what occurred error is

2.1.79 Film Mode Control

- **Function**

Control the device film mode. Film mode make frame transitions from older video sources smoother.

- **Get**

Header	Command	ID	Data Length	Check Sum
0xAA	0x79		0x00	

- **Set**

Header	Command	ID	Data Length	Data 1	Check Sum
0xAA	0x79		0x01	Fmode	

Fmode : Film Mode code to be set on TV/Monitor

0x00	Film Mode OFF
0x01	Film Mode Auto1
0x02	Film Mode Auto2
0x03	Film Cinema Smooth

- **Ack**

Header	Command	ID	Data Length	Ack/Nak	r-CMD	Val 1	Check Sum
0xAA	0xFF		0x03	'A'	0x79	Fmode	

Fmode : Same as above

- **Nak**

Header	Command	ID	Data Length	Ack/Nak	r-CMD	Val 1	Check Sum
0xAA	0xFF		0x03	'N'	0x79	ERR	

ERR : Error code that shows what occurred error is

2.1.83 Panel On Time

- **Function**

Get the device panel on time

- **Get**

Header	Command	ID	Data Length	Check Sum
0xAA	0x83		0x00	

- **Set**

Not Support

- **Ack**

Header	Command	ID	Data Length	Ack/Nak	r-CMD	Val 1	Val 2
0xAA	0xFF		0x04	'A'	0x83	Ptime_H	Ptime_L
Check Sum							

Ptime_H : Panel On Time data High byte.

Ptime_L : Panel On Time data Low byte.

Note : Return value will increase every 10 mins.

- **Nak**

Header	Command	ID	Data Length	Ack/Nak	r-CMD	Val 1	Check Sum
0xAA	0xFF		0x03	'N'	0x83	ERR	

ERR : Error code that shows what occurred error is

2.1.84 Video Wall On

- **Function**

Control the device video wall mode

Note : Will not work in MagicNet source.

- **Get**

Header	Command	ID	Data Length	Check Sum
0xAA	0x84		0x00	

- **Set**

Header	Command	ID	Data Length	Data 1	Check Sum
0xAA	0x84		0x01	V.Wall_On	

V.Wall_On : Video Wall Code to set on Device

0x00	Video Wall OFF	0x01	Video Wall ON
------	----------------	------	---------------

- **Ack**

Header	Command	ID	Data Length	Ack/Nak	r-CMD	Val 1	Check Sum
0xAA	0xFF		0x03	'A'	0x84	V.Wall_On	

V.Wall_On : Same as above

- **Nak**

Header	Command	ID	Data Length	Ack/Nak	r-CMD	Val 1	Check Sum
0xAA	0xFF		0x03	'N'	0x84	ERR	

ERR : Error code that shows what occurred error is

2.1.85 Temperature Control

- **Function**

Control the device temperature threshold value which is makes the auto power off when device temperature is over than this.

Note : Depends on the product spec, it will work or not

- **Get**

Header	Command	ID	Data Length	Check Sum
0xAA	0x85		0x00	

- **Set**

Header	Command	ID	Data Length	Data 1	Check Sum
0xAA	0x85		0x01	Temperature	

Temperature : Temperature code to be set on TV/Monitor(75 ~ 124 °C)

- **Ack**

Header	Command	ID	Data Length	Ack/Nak	r-CMD	Val 1	Check Sum
0xAA	0xFF		0x03	'A'	0x85	Temperature	

Temperature : Same as above

- **Nak**

Header	Command	ID	Data Length	Ack/Nak	r-CMD	Val 1	Check Sum
0xAA	0xFF		0x03	'N'	0x85	ERR	

ERR : Error code that shows what occurred error is

2.1.86 Brightness Sensor

- **Function**

Control the device brightness sensor mode

Note : Based on the product spec this command control the Eco Sensor on the menu

- **Get**

Header	Command	ID	Data Length	Check Sum
0xAA	0x86		0x00	

- **Set**

Header	Command	ID	Data Length	Data 1	Check Sum
0xAA	0x86		0x01	BR_Sensor	

BR_Sensor : Brightness Sensor Code to be set on TV/Monitor

0x00	Brightness Sensor OFF	0x01	Brightness Sensor ON
------	-----------------------	------	----------------------

- **Ack**

Header	Command	ID	Data Length	Ack/Nak	r-CMD	Val 1	Check Sum
0xAA	0xFF		0x03	'A'	0x86	BR_Sensor	

BR_Sensor : Same as above

- **Nak**

Header	Command	ID	Data Length	Ack/Nak	r-CMD	Val 1	Check Sum
0xAA	0xFF		0x03	'N'	0x86	ERR	

ERR : Error code that shows what occurred error is

2.1.87 Dynamic Contrast

- **Function**

Control the device dynamic contrast which makes automatic contrast balance

Note : It will be work or not depends on the Picture mode

Depends on the product spec it will work as contrast enhancer

- **Get**

Header	Command	ID	Data Length	Check Sum
0xAA	0x87		0x00	

- **Set**

Header	Command	ID	Data Length	Data 1	Check Sum
0xAA	0x87		0x01	DY_Cont	

DY_Cont : Dynamic Contrast code to be set on TV/Monitor

0x00	Dynamic Contrast OFF
0x01	Dynamic Contrast Low(ON)
0x02	Dynamic Contrast Medium
0x03	Dynamic Contrast High

- **Ack**

Header	Command	ID	Data Length	Ack/Nak	r-CMD	Val 1	Check Sum
0xAA	0xFF		0x03	'A'	0x87	DY_Cont	

_Cont : Same as above

- **Nak**

Header	Command	ID	Data Length	Ack/Nak	r-CMD	Val 1	Check Sum
0xAA	0xFF		0x03	'N'	0x87	ERR	

ERR : Error code that shows what occurred error is

2.1.89 Video Wall User Control

● Function

Control the device video wall related things like whole screen division and device number

Note : Does not operate in MagicNet mode.

● Get

Header	Command	ID	Data Length	Check Sum
0xAA	0x89		0x00	

● Set

Header	Command	ID	Data Length	Data 1	Data 2	Check Sum
0xAA	0x89		0x02	Wall_Div	Wall_Sno	

Wall_Div : Video Wall Divider code set on TV/Monitor

Note : It is dependent on Product Specifications.

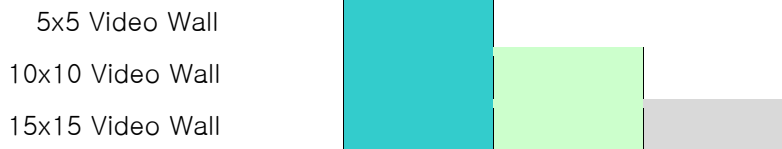

V H	1	2	3	4	5	6	7	8	9	10	11	12	13	14	15
OFF	0x00	0x00	0x00	0x00	0x00	0x00	0x00	0x00	0x00	0x00	0x00	0x00	0x00	0x00	0x00
1	0x11	0x12	0x13	0x14	0x15	0x16	0x17	0x18	0x19	0x1A	0x1B	0x1C	0x1D	0x1E	0x1F
2	0x21	0x22	0x23	0x24	0x25	0x26	0x27	0x28	0x29	0x2A	0x2B	0x2C	0x2D	0x2E	0x2F
3	0x31	0x32	0x33	0x34	0x35	0x36	0x37	0x38	0x39	0x3A	0x3B	0x3C	0x3D	0x3E	0x3F
4	0x41	0x42	0x43	0x44	0x45	0x46	0x47	0x48	0x49	0x4A	0x4B	0x4C	0x4D	0x4E	0x4F
5	0x51	0x52	0x53	0x54	0x55	0x56	0x57	0x58	0x59	0x5A	0x5B	0x5C	0x5D	0x5E	0x5F
6	0x61	0x62	0x63	0x64	0x65	0x66	0x67	0x68	0x69	0x6A	0x6B	0x6C	0x6D	0x6E	0x6F
7	0x71	0x72	0x73	0x74	0x75	0x76	0x77	0x78	0x79	0x7A	0x7B	0x7C	0x7D	0x7E	0x7F
8	0x81	0x82	0x83	0x84	0x85	0x86	0x87	0x88	0x89	0x8A	0x8B	0x8C	0x8D	0x8E	0x8F
9	0x91	0x92	0x93	0x94	0x95	0x96	0x97	0x98	0x99	0x9A	0x9B	0x9C	0x9D	0x9E	0x9F
10	0xA1	0xA2	0xA3	0xA4	0xA5	0xA6	0xA7	0xA8	0xA9	0xAA	0xAB	0xAC	0xAD	0xAE	0xAF
11	0xB1	0xB2	0xB3	0xB4	0xB5	0xB6	0xB7	0xB8	0xB9	0xBA	0xBB	0xBC	0xBD	0xBE	0xBF
12	0xC1	0xC2	0xC3	0xC4	0xC5	0xC6	0xC7	0xC8	0xC9	0xCA	0xCB	0xCC	0xCD	0xCE	0xCF
13	0xD1	0xD2	0xD3	0xD4	0xD5	0xD6	0xD7	0xD8	0xD9	0xDA	0xDB	0xDC	0xDD	0xDE	0xDF
14	0xE1	0xE2	0xE3	0xE4	0xE5	0xE6	0xE7	0xE8	0xE9	0xEA	0xEB	0xEC	0xED	0xEE	0xEF
15	0xF1	0xF2	0xF3	0xF4	0xF5	0xF6	0xF7	0xF8	0xF9	0xFA	0xFB	0xFC	0xFD	0xFE	0xFF

Wall_Sno : Device 에 설정된 TV/Monitor 의 Number code.

- 5x5 Video Wall Model : (1 ~ 25)
- 10x10 Video Wall Model : (1 ~ 100)
- 15x15 Video Wall Model : (1 ~ 225)

● Ack

Header	Command	ID	Data Length	Ack/Nak	r-CMD	Val 1	Val 2
0xAA	0xFF		0x04	'A'	0x89	Wall_Div	Wall_Sno
Check Sum							

Wall_Div, Wall_Sno : Same as above

- Nak

Header	Command	ID	Data Length	Ack/Nak	r-CMD	Val 1	Check Sum
0xAA	0xFF		0x03	'N'	0x89	ERR	

ERR : Error code that shows what occurred error is

2.1.8A Model Name Control

- **Function**

Get the device model name

- **Get**

Header	Command	ID	Data Length	Check Sum
0xAA	0x8A		0x00	

- **Set**

Not Support

- **Ack**

Header	Command	ID	Data Length	Ack/Nak	r-CMD	Val 1	Val 2
0xAA	0xFF		Length	'A'	0x8A	M_Name1	M_Name2
Val 3	Val 4	Val 5	Val 6	Val 7	Val 8	Val 9	Val 10
M_Name3	M_Name4	M_Name5	M_Name6	M_Name7	M_Name8	M_Name9	M_Name10
Val 11	Val 12	Val 13	Val 14	Val 15	Val 16	Val 17	Val ...
M_Name11	M_Name12	M_Name13	M_Name14	M_Name15	M_Name16	M_Name17	M_Name...
Check Sum							

M_Name1 ~ M_Name... : Device's Model Name.

Length : Length means number of **M_Name** elements & Ack/Nak & r-CMD.

Ex) SyncMaster400DXn

M_Name1	M_Name2	M_Name3	M_Name4	M_Name5	M_Name6	M_Name7	M_Name8
'S'	'y'	'n'	'c'	'M'	'a'	's'	't'
M_Name9	M_Name10	M_Name11	M_Name12	M_Name13	M_Name14	M_Name15	M_Name16
'e'	'r'	'4'	'0'	'0'	'D'	'X'	'n'

- **Nak**

Header	Command	ID	Data Length	Ack/Nak	r-CMD	Val 1	Check Sum
0xAA	0xFF		0x03	'N'	0x8A	ERR	

ERR : Error Code showing what occurred error is.

2.1.8B Video Wall Direct User Control

● Function

Control the device video wall related things like On/Off, mode, whole screen division, device number and input

Note : This does not operate while PIP is operating.

● Get

Header	Command	ID	Data Length	Check Sum
0xAA	0x8B		0x00	

● Set

Header	Command	ID	Data Length	Data 1	Data 2	Data 3	Data 4
0xAA	0x8B		0x05	V.Wall_On	WallMode	Wall_Div	Wall_Sno
Data 5	Check Sum						
Input							

V.Wall_On: The Video Wall code to set for the TV or monitor.

0x00	Video Wall OFF	0x01	Video Wall ON
------	----------------	------	---------------

WallMode: The Video Wall mode code to set for the TV or monitor.

0x00	Natural	0x01	Full
------	---------	------	------

Wall_Div: The Video Wall Divider code set for the TV or monitor.

– Please refer Wall_Div table of Command 0x89, Video Wall User Control

Wall_Sno: The TV/Monitor serial number code set for the TV or monitor.

– Please refer Wall_Sno table of Command 0x89, Video Wall User Control

Input : The input source code to set for the TV or monitor.

– Please refer Input table of Command 0x14, Input Source Control (MFM).

● Ack

Header	Command	ID	Data Length	Ack/Nak	r-CMD	Val 1	Val 2
0xAA	0xFF		0x07	'A'	0x8B	V.Wall_On	WallMode
Val 3	Val 4	Val 5	Check Sum				
Wall_Div	Wall_Sno	Input					

Val 1 ~ Val 5 : Same as above

● Nak

Header	Command	ID	Data Length	Ack/Nak	r-CMD	Val 1	Check Sum
0xAA	0xFF		0x03	'N'	0x8B	ERR	

ERR : Error Code showing what occurred error is.

2.1.8C Video Wall Feature Control

- **Function**

Control video wall related function

- **Working Condition**

Depends on each model spec it will be supported or not

- **Sub Command Table**

Sub CMD	Function	Sub CMD	Function
-	-	0x81	Frams Alignment

2.1.8C.81 Frame Alignment

- **Function**

Control the frame alignment of the device

- **Get**

Header	Command	ID	Data Length	Sub CMD	Check Sum
0xAA	0x8c		0x01	0x81	

- **Set**

Header	Command	ID	Data Length	Sub CMD	Data1	Check Sum
0xAA	0x8c		0x02	0x81	Frame Alignment Mode	

Frame Alignment Mode

0x00	Off	0x01	On
0x02	Auto	-	-

- **Ack**

Header	Command	ID	Data Length	Ack	r-CMD	Sub CMD	Val1
0xAA	0xFF		0x04	'A'	0x8c	0x81	Frame Alignment Mode
Check Sum							

Frame Alignment Mode : Same as above

- **Nak**

Header	Command	ID	Data Length	Nak	r-CMD	r-Sub Cmd	Val1
0xAA	0xFF		0x04	'N'	0x8c	0x81	ERR
Check Sum							

ERR : Error code that shows what occurred error is

2.1.8F Fan Control

- **Function**

Control the device fan mode

- **Get**

Header	Command	ID	Data Length	Check Sum
0xAA	0x8F		0x00	

- **Set**

Header	Command	ID	Data Length	Data 1	Check Sum
0xAA	0x8F		0x01	FAN	

FAN : Fan Control code to be set on TV/Monitor

0x00	Fan Control Manual	0x01	Fan Control Auto
0x02	Fan Control Off	0x03	Fan Control On

Note : Depends on each model spec it will be supported or not

- **Ack**

Header	Command	ID	Data Length	Ack/Nak	r-CMD	Val 1	Check Sum
0xAA	0xFF		0x03	'A'	0x8F	FAN	

FAN : Same as above

- **Nak**

Header	Command	ID	Data Length	Ack/Nak	r-CMD	Val 1	Check Sum
0xAA	0xFF		0x03	'N'	0x8F	ERR	

ERR : Error code that shows what occurred error is

2.1.90 Game Mode Control

- **Function**

Control the device game mode

Note : Depends on each model spec it will be supported or not

- **Get**

Header	Command	ID	Data Length	Check Sum
0xAA	0x90		0x00	

- **Set**

Header	Command	ID	Data Length	Data 1	Check Sum
0xAA	0x90		0x01	Game Mode	

Game Mode : Game Mode Control value

0x00	Game Mode Control OFF	0x01	Game Mode Control ON
------	-----------------------	------	----------------------

- **Ack**

Header	Command	ID	Data Length	Ack/Nak	r-CMD	Val 1	Check Sum
0xAA	0xFF		0x03	'A'	0x90	Game Mode	

Game Mode : Same as above

- **Nak**

Header	Command	ID	Data Length	Ack/Nak	r-CMD	Val 1	Check Sum
0xAA	0xFF		0x03	'N'	0x90	ERR	

ERR : Error code that shows what occurred error is

2.1.92 Energy Saving Control

- **Function**

Control the device energy saving mode which makes power consumption adjusting through brightness control

- **Get**

Header	Command	ID	Data Length	Check Sum
0xAA	0x92		0x00	

- **Set**

Header	Command	ID	Data Length	Data 1	Check Sum
0xAA	0x92		0x01	E_SAV	

Energy Saving : Energy Saving code to be set on TV/Monitor

0x00	Energy Saving Control OFF
0x01	Energy Saving Control Low(ON)
0x02	Energy Saving Control Medium
0x03	Energy Saving Control High
0x04	Energy Saving Picture Off

- **Ack**

Header	Command	ID	Data Length	Ack/Nak	r-CMD	Val 1	Check Sum
0xAA	0xFF		0x03	'A'	0x92	E_SAV	

E_SAV : Same as above

- **Nak**

Header	Command	ID	Data Length	Ack/Nak	r-CMD	Val 1	Check Sum
0xAA	0xFF		0x03	'N'	0x92	ERR	

ERR : Error code that shows what occurred error is

2.1.94 HDMI Black Level Control

- **Function**

Control the device HDMI black level which makes black level adjusting for the HDMI picture brightness and contrast optimization

- **Get**

Header	Command	ID	Data Length	Check Sum
0xAA	0x94		0x00	

- **Set**

Header	Command	ID	Data Length	Data 1	Check Sum
0xAA	0x94		0x01	HDMI Black Level	

HDMI Black Level : HDMI Black Level Control code set on TV/Monitor

0x00	Normal
0x01	Low
0x02	Auto

- **Ack**

Header	Command	ID	Data Length	Ack/Nak	r-CMD	Val 1	Check Sum
0xAA	0xFF		0x03	'A'	0x94	HDMI Black Level	

HDMI Black Level : Same as above

- **Nak**

Header	Command	ID	Data Length	Ack/Nak	r-CMD	Val 1	Check Sum
0xAA	0xFF		0x03	'N'	0x94	ERR	

ERR : Error code that shows what occurred error is

2.1.95 Black Adjust Control

- **Function**

Control the device black adjustment which enhances picture depth by adjusting black color depth

Note : Depends on each model spec it will be supported or not

Depends on the product spec it can be worked as black tone

- **Get**

Header	Command	ID	Data Length	Check Sum
0xAA	0x95		0x00	

- **Set**

Header	Command	ID	Data Length	Data 1	Check Sum
0xAA	0x95		0x01	B_ADJ	

B_ADJ : Black Adjust Control Value

0x00	Black Adjust Control OFF or Off
0x01	Black Adjust Control Low(ON) or Dark
0x02	Black Adjust Control Medium or Darker
0x03	Black Adjust Control High or Darkest

- **Ack**

Header	Command	ID	Data Length	Ack/Nak	r-CMD	Val 1	Check Sum
0xAA	0xFF		0x03	'A'	0x95	B_ADJ	

B_ADJ : Same as above

- **Nak**

Header	Command	ID	Data Length	Ack/Nak	r-CMD	Val 1	Check Sum
0xAA	0xFF		0x03	'N'	0x95	ERR	

ERR : Error code that shows what occurred error is

2.1.96 Gamma Control

- **Function**

Control the device gamma vaue

- **Get**

Header	Command	ID	Data Length	Check Sum
0xAA	0x96		0x00	

- **Set**

Header	Command	ID	Data Length	Data 1	Check Sum
0xAA	0x96		0x01	GAMMA	

GAMMA : Gamma code to be set on TV/Monitor

0x00	Natural (0)
0x01	Mode1 (1)
0x02	Mode2 (2)
0x03	Mode3 (3)
0x04	Mode4 (4)
0x05	Mode5 (5)
0x11	-1
0x12	-2
0x13	-3
0x14	-4
0x15	-5
0x20	Custom

- **Ack**

Header	Command	ID	Data Length	Ack/Nak	r-CMD	Val 1	Check Sum
0xAA	0xFF		0x03	'A'	0x96	GAMMA	

GAMMA : Same as above

- **Nak**

Header	Command	ID	Data Length	Ack/Nak	r-CMD	Val 1	Check Sum
0xAA	0xFF		0x03	'N'	0x96	ERR	

ERR : Error code that shows what occurred error is

2.1.9C Edge Enhancement Control

- **Function**

Control the device edge enhancement

Note : Depends on each model spec it will be supported or not

- **Get**

Header	Command	ID	Data Length	Check Sum
0xAA	0x9C		0x00	

- **Set**

Header	Command	ID	Data Length	Data 1	Check Sum
0xAA	0x9C		0x01	EDGE	

EDGE : Edge Enhancement Control value set on TV/Monitor

0x00	Edge Enhancement Control OFF	0x01	Edge Enhancement Control ON
------	------------------------------	------	-----------------------------

- **Ack**

Header	Command	ID	Data Length	Ack/Nak	r-CMD	Val 1	Check Sum
0xAA	0xFF		0x03	'A'	0x9C	EDGE	

EDGE : Same as above

- **Nak**

Header	Command	ID	Data Length	Ack/Nak	r-CMD	Val 1	Check Sum
0xAA	0xFF		0x03	'N'	0x9C	ERR	

ERR : Error code that shows what occurred error is

2.1.9D Color Space Control

● Function

Control the device color space which refine the spectrum of colors

Note :

1. A product which has **** Text , **** Video/Image and Calibration as picture mode,
 - It will work in case of PIC_MODE is PIC_MODE_VIDEO
 - * For the PIC_MODE definition pls refer AnnexB

● Get

Header	Command	ID	Data Length	Check Sum
0xAA	0x9D		0x00	

● Set

Header	Command	ID	Data Length	Data 1	Check Sum
0xAA	0x9D		0x01	Color Space	

Color Space : Color Space Control value set on TV/Monitor

0x00	Auto	0x01	Native
0x02	Custom	0x03	DCI-P3
0x04	Adobe RGB	0x05	BT-709

Note : Each option will be supported or not by product spec

● Ack

Header	Command	ID	Data Length	Ack/Nak	r-CMD	Val 1	Check Sum
0xAA	0xFF		0x03	'A'	0x9D	Color Space	

Color Space : Same as above

● Nak

Header	Command	ID	Data Length	Ack/Nak	r-CMD	Val 1	Check Sum
0xAA	0xFF		0x03	'N'	0x9D	ERR	

ERR : Error code that shows what occurred error is

2.1.9E xvYCC Control

- **Function**

Control the device xvYcc model

Note : Depends on each model spec it will be supported or not

- **Get**

Header	Command	ID	Data Length	Check Sum
0xAA	0x9E		0x00	

- **Set**

Header	Command	ID	Data Length	Data 1	Check Sum
0xAA	0x9E		0x01	XVYCC	

XVYCC : xvYCC Control code set on TV/Monitor

0x00	xvYCC Control OFF	0x01	xvYCC Control ON
------	-------------------	------	------------------

- **Ack**

Header	Command	ID	Data Length	Ack/Nak	r-CMD	Val 1	Check Sum
0xAA	0xFF		0x03	'A'	0x9E	XVYCC	

xvYCC : Same as above

- **Nak**

Header	Command	ID	Data Length	Ack/Nak	r-CMD	Val 1	Check Sum
0xAA	0xFF		0x03	'N'	0x9E	ERR	

ERR : Error code that shows what occurred error is

2.1.9F Reset Control

- **Function**

Do the device menu item reset for a specified category

- **Get**

Not Support

- **Set**

Header	Command	ID	Data Length	Data 1	Check Sum
0xAA	0x9F		0x01	RST	

RST : Reset code to be set on TV/Monitor

0x00	Picture Reset
0x01	Sound Reset
0x02	Setup Reset(System Reset)
0x03	Reset All
0x04	Screen Display Reset

- **Ack**

Header	Command	ID	Data Length	Ack/Nak	r-CMD	Val 1	Check Sum
0xAA	0xFF		0x03	'A'	0x9F	RST	

RST : Same as above

- **Nak**

Header	Command	ID	Data Length	Ack/Nak	r-CMD	Val 1	Check Sum
0xAA	0xFF		0x03	'N'	0x9F	ERR	

ERR : Error code that shows what occurred error is

2.1.A1 Ambient Brightness Mode

- **Function**

Control the device ambient mode related things like mode and lamp value

- **Get**

Header	Command	ID	Data Length	Check Sum
0xAA	0xA1		0x00	

- **Set**

Header	Command	ID	Data Length	Data 1	Data 2	Data 3	Check Sum
0xAA	0xA1		0x03	AB_Mode	Valid_LampValue	Lamp Value	

AB_Mode: Ambient Mode On/Off code to be set on TV/Monitor

0x00	Ambient Brightness Mode Off	0x01	Ambient Brightness Mode On
------	-----------------------------	------	----------------------------

Valid_LampValue : Lamp Value Apply/Not apply to be set on TV/Monitor

0x00	Invalid Lamp Value(Don't apply)	0x01	Valid Lamp Value (Apply)
------	---------------------------------	------	--------------------------

Lamp Value : Lamp Value to be set on TV/Monitor (0 ~ 100),

- **Ack**

Header	Command	ID	Data Length	Ack/Nak	r-CMD	Val 1	Val 2
0xAA	0xFF		0x04	'A'	0xA1	AB_Mode	Lamp Value
Check Sum							

AB_Mode, Valid_LampValue, Lamp Value : Same as above

- **Nak**

Header	Command	ID	Data Length	Ack/Nak	r-CMD	Val 1	Check Sum
0xAA	0xFF		0x03	'N'	0xA1	ERR	

ERR : Error code that shows what occurred error is

2.1.A3 OSD Display Type On/Off

● Function

Control the device OSD mode for a specified category

Note : “OSD On” means, Display OSD which is set on OSD Type.

“OSD Off” means, Does not display which is set on OSD Type.

● Get

Header	Command	ID	Data Length	Check Sum
0xAA	0xA3		0x00	

● Set

Header	Command	ID	Data Length	Data 1	Data 2	Check Sum
0xAA	0xA3		0x02	OSD Type	OSD On/Off	

OSD Type: Select OSD Type code to be set on TV/Monitor

0x00	Source OSD	0x01	Not Optimum Mode OSD
0x02	No Signal OSD	0x03	MDC OSD
0x04	Schedule Channel Info	-	-

Note : Depends on the product “0x04 Schedule Channel Info” is worked as Download Satus Message

OSD ON/OFF: Adjust OSD On/Off code to be set on TV/Monitor

0x00	OSD Off	0x01	OSD On
------	---------	------	--------

● Ack

Header	Command	ID	Data Length	Ack/Nak	r-CMD	Val1	Check Sum
0xAA	0xFF		0x03	'A'	0xA3	OSD Status	

OSD Status : Each OSD status, 0:Off, 1:On.

BIT7	BIT6	BIT5	BIT4	BIT3	BIT2	BIT1	BIT0
Reserved	Reserved	Reserved	Schedule Channel Info	MDC	No Signal	Not Optimum Mode	Source

● Nak

Header	Command	ID	Data Length	Ack/Nak	r-CMD	Val 1	Check Sum
0xAA	0xFF		0x03	'N'	0xA3	ERR	

ERR : Error code that shows what occurred error is

2.1.A4 Timer1 Control_MFM

- **Function:**

Control the device timer 1 related things like on timer hour/min/am/pm/on.off, off timer hour/min/am/pm/on.off, repeat, manual weekday setting, ontimer volume/source and holiday apply

Note : It is dependent on Product Specifications.

- **Get**

Header	Command	ID	Data Length	Check Sum
0xAA	0xA4		0x00	

- **Set**

On Timer/Off Timer Integrated.

Header	Command	ID	Data Length	Data 1	Data 2	Data 3	Data 4
0xAA	0xA4		0x0D	On H	On M	On AM/PM	On_Act
Data 5	Data 6	Date 7	Data 8	Data 9	Data 10	Data 11	Data 12
Off H	Off M	Off AM/PM	Off_Act	Repeat	Manual Weekday	Volume	Source
Data 13	Check Sum						
Holiday Apply							

On Timer/Off Timer Separated (Added two Items, Data Length is different)

Header	Command	ID	Data Length	Data 1	Data 2	Data 3	Data 4
0xAA	0xA4		0x0F	On H	On M	On AM/PM	On_Act
Data 5	Data 6	Date 7	Data 8	Data 9	Data 10	Data 11	Data 12
Off H	Off M	Off AM/PM	Off_Act	Repeat_On	Manual WeekdayOn	Repeat_Off	Manual WeekdayOff
Data 13	Data 14	Data 15	Check Sum				
Volume	Source	Holiday Apply					

On H : On Time Hour value to be set on TV/Monitor (1 ~ 12)

On M : On Time Minute value to be set on TV/Monitor (0 ~ 59)

On AM/PM : On Time AM/PM value to be set on TV/Monitor (0~1)

0x00	PM	0x01	AM
------	----	------	----

On_Act : On Time Inactivated /Activated to be set on TV/Monitor (0(off)~1(on))

Off H : Off Time Hour value to be set on TV/Monitor (1 ~ 12)

Off M : Off Time Minute value to be set on TV/Monitor (0 ~ 59)

Off AM/PM : Off Time AM/PM value to be set on TV/Monitor (0~1)

0x00	PM	0x01	AM
------	----	------	----

Off_Act : Off Time Inactivated /Activated to be set on TV/Monitor (0(off)~1(on))

Repeat_On/Repeat Off : Repeat value to be set on TV/Monitor (0~5)

0x00	Once	0x01	Everyday
0x02	Mon~Fri	0x03	Mon~Sat
0x04	Sat~Sun	0x05	Manual Weekday

ManualWeekday/ManualWeekdayOn/ManualWeekdayOff : Weekday value to be set on TV/Monitor.

BIT7	BIT6	BIT5	BIT4	BIT3	BIT2	BIT1	BIT0
X	Sat	Fri	Thu	Wed	Tue	Mon	Sun

Note : Don't care for BIT7

Volume : Volume to be set on TV/Monitor.

Source : Source to be set on TV/Monitor.

Note : 0x61, WiDi is not available, 0x62 : Internal/USB, USB

Holiday Apply : Apply or not the Holiday to On/Off Timer1 (0 ~ 3)

0x00	Dont't Apply(Both)	0x01	Apply(Both)
0x02	On Timer1 only Apply	0x03	Off Timer1 only Apply

● **Ack**

On Timer/Off Timer Integrated

Header	Command	ID	Data Length	Ack/Nak	r-CMD	Val 1	Val 2
0xAA	0xFF	ID	0x0F	'A'	0xA4	On H	On M
Val 3	Val 4		Val 5	Val 6	Val 7	Val 8	Val 9
On AM/PM	On_Act	Off H	Off M	Off AM/PM	Off_Act	Repeat	Manula Weekday
Val 11	Val 12	Val 13	Check Sum				
Volume	Source	Holiday Apply					

On Timer/Off Timer Separated (Added two Items, Data Length is different)

Header	Command	ID	Data Length	Ack/Nak	r-CMD	Val 1	Val 2
0xAA	0xFF	ID	0x11	'A'	0xA4	On H	On M
Va 3	Val 4		Val 5	Val 6	Val 7	Val 8	Val 9
On AM/PM	On_Act	Off H	Off M	Off AM/PM	Off_Act	Repeat_On	Manual WeekdayOn
Val 11	Val 12	Val 13	Val 14	Val 15	Check Sum		
Repeat_Off	Manual Week dayOff	Volume	Source	Holiday Apply			

Val1 ~ Val15 : Same as above

Note : If H/M Time values are 0xFF, Time didn't set in LFD.

● **Nak**

Header	Command	ID	Data Length	Ack/Nak	r-CMD	Val 1	Check Sum
0xAA	0xFF	ID	0x03	'N'	0xA4	ERR	Check Sum

ERR : Error code that shows what occurred error is

2.1.A5 Timer2 Control_MFM

- **Function:**

Control the device timer 2 related things like on timer hour/min/am/pm/on.off, off timer hour/min/am/pm/on.off, repeat, manual weekday setting, ontimer volume/source and holiday apply

Note : It is dependent on Product Specifications.

- **Get**

Header	Command	ID	Data Length	Check Sum
0xAA	0xA5		0x00	

- **Set**

On Timer/Off Timer Integrated

Header	Command	ID	Data Length	Data 1	Data 2	Data 3	Data 4
0xAA	0xA5		0x0D	On H	On M	On AM/PM	On_Act
Data 5	Data 6	Date 7	Data 8	Data 9	Data 10	Data 11	Data 12
Off H	Off M	Off AM/PM	Off_Act	Repeat	Manual Weekday	Volume	Source
Data 13	Check Sum						
Holiday Apply							

On Timer/Off Timer Separated (Added two Items, Data Length is different)

Header	Command	ID	Data Length	Data 1	Data 2	Data 3	Data 4
0xAA	0xA5		0x0F	On H	On M	On AM/PM	On_Act
Data 5	Data 6	Date 7	Data 8	Data 9	Data 10	Data 11	Data 12
Off H	Off M	Off AM/PM	Off_Act	Repeat_On	Manual WeekdayOn	Repeat_Off	Manual WeekdayOff
Data 13	Data 14	Data 15	Check Sum				
Volume	Source	Holiday Apply					

On H : On Time Hour value to be set on TV/Monitor (1 ~ 12)

On M : On Time Minute value to be set on TV/Monitor (0 ~ 59)

On AM/PM : On Time AM/PM value to be set on TV/Monitor (0~1)

0x00	PM	0x01	AM
------	----	------	----

On_Act : On Time Inactivated /Activated to be set on TV/Monitor (0(off)~1(on))

Off H : Off Time Hour value to be set on TV/Monitor (1 ~ 12)

Off M : Off Time Minute value to be set on TV/Monitor (0 ~ 59)

Off AM/PM : Off Time AM/PM value to be set on TV/Monitor (0~1)

0x00	PM	0x01	AM
------	----	------	----

Off_Act : Off Time Inactivated /Activated to be set on TV/Monitor (0(off)~1(on))

Repeat_On/Repeat Off : Repeat value to be set on TV/Monitor (0~5)

0x00	Once	0x01	Everyday
0x02	Mon~Fri	0x03	Mon~Sat
0x04	Sat~Sun	0x05	Manual Weekday

ManualWeekday/ManualWeekdayOn/ManualWeekdayOff : Weekday value to be set on TV/Monitor.

BIT7	BIT6	BIT5	BIT4	BIT3	BIT2	BIT1	BIT0
X	Sat	Fri	Thu	Wed	Tue	Mon	Sun

Note : Don't care for BIT7

Volume : Volume to be set on TV/Monitor.

Source : Source to be set on TV/Monitor.

Note : 0x61, WiDi is not available, 0x62 : Internal/USB, USB

Holiday Apply : Apply or not the Holiday to On/Off Timer2 (0 ~ 3)

0x00	Dont't Apply(Both)	0x01	Apply(Both)
0x02	On Timer2 only Apply	0x03	Off Timer2 only Apply

● **Ack**

On Timer/Off Timer Integrated

Header	Command	ID	Data Length	Ack/Nak	r-CMD	Val 1	Val 2
0xAA	0xFF		ID	0x0F	'A'	0xA5	On H
Val 3	Val 4	Val 6		Val 7	Val 8	Val 9	Val 10
On AM/PM	On_Act	Off H	Off M	Off AM/PM	Off_Act	Repeat	Manula Weekday
Val 11	Val 12	Val 13	Check Sum				
Volume	Source	Holiday Apply					

On Timer/Off Timer Separated (Added two Items, Data Length is different)

Header	Command	ID	Data Length	Ack/Nak	r-CMD	Val 1	Val 2
0xAA	0xFF		ID	0x11	'A'	0xA5	On H
Va 3	Val 4	Val 6		Val 7	Val 8	Val 9	Val 10
On AM/PM	On_Act	Off H	Off M	Off AM/PM	Off_Act	Repeat_On	Manual WeekdayOn
Val 11	Val 12	Val 13	Val 14	Val 15	Check Sum		
Repeat_Off	Manual Week dayOff	Volume	Source	Holiday Apply			

Val1 ~ Val15 : Same as above

Note : If H/M Time values are 0xFF, Time didn't set in LFD.

● **Nak**

Header	Command	ID	Data Length	Ack/Nak	r-CMD	Val 1	Check Sum
0xAA	0xFF		ID	0x03	'N'	0xA5	

ERR : Error code that shows what occurred error is

2.1.A6 Timer3 Control_MFM

- **Function:**

Control the device timer 3 related things like on timer hour/min/am.pm/on.off, off timer hour/min/am.pm/on.off, repeat, manual weekday setting, ontimer volume/source and holiday apply

Note : It is dependent on Product Specifications.

- **Get**

Header	Command	ID	Data Length	Check Sum
0xAA	0xA6		0x00	

- **Set**

On Timer/Off Timer Integrated.

Header	Command	ID	Data Length	Data 1	Data 2	Data 3	Data 4
0xAA	0xA6		0x0D	On H	On M	On AM/PM	On_Act
Data 5	Data 6	Date 7	Data 8	Data 9	Data 10	Data 11	Data 12
Off H	Off M	Off AM/PM	Off_Act	Repeat	Manual Weekday	Volume	Source
Data 13	Check Sum						
Holiday Apply							

On Timer/Off Timer Separated (Added two Items, Data Length is different)

Header	Command	ID	Data Length	Data 1	Data 2	Data 3	Data 4
0xAA	0xA6		0x0F	On H	On M	On AM/PM	On_Act
Data 5	Data 6	Date 7	Data 8	Data 9	Data 10	Data 11	Data 12
Off H	Off M	Off AM/PM	Off_Act	Repeat_On	Manual WeekdayOn	Repeat_Off	Manual WeekdayOff
Data 13	Data 14	Data 15	Check Sum				
Volume	Source	Holiday Apply					

On H : On Time Hour value to be set on TV/Monitor (1 ~ 12)

On M : On Time Minute value to be set on TV/Monitor (0 ~ 59)

On AM/PM : On Time AM/PM value to be set on TV/Monitor (0~1)

0x00	PM	0x01	AM
------	----	------	----

On_Act : On Time Inactivated /Activated to be set on TV/Monitor (0(off)~1(on))

Off H : Off Time Hour value to be set on TV/Monitor (1 ~ 12)

Off M : Off Time Minute value to be set on TV/Monitor (0 ~ 59)

Off AM/PM : Off Time AM/PM value to be set on TV/Monitor (0~1)

0x00	PM	0x01	AM
------	----	------	----

Off_Act : Off Time Inactivated /Activated to be set on TV/Monitor (0(off)~1(on))

Repeat_On/Repeat Off : Repeat value to be set on TV/Monitor (0~5)

0x00	Once	0x01	Everyday
0x02	Mon~Fri	0x03	Mon~Sat
0x04	Sat~Sun	0x05	Manual Weekday

ManualWeekday/ManualWeekdayOn/ManualWeekdayOff : Weekday value to be set on TV/Monitor.

BIT7	BIT6	BIT5	BIT4	BIT3	BIT2	BIT1	BIT0
X	Sat	Fri	Thu	Wed	Tue	Mon	Sun

Note : Don't care for BIT7

Volume : Volume to be set on TV/Monitor.

Source : Source to be set on TV/Monitor.

Note : 0x61, WiDi is not available, 0x62 : Internal/USB, USB

Holiday Apply : Apply or not the Holiday to On/Off Timer3 (0 ~ 3)

0x00	Dont't Apply(Both)	0x01	Apply(Both)
0x02	On Timer3 only Apply	0x03	Off Timer3 only Apply

● **Ack**

On Timer/Off Timer Integrated

Header	Command	ID	Data Length	Ack/Nak	r-CMD	Val 1	Val 2
0xAA	0xFF		0x0F	'A'	0xA6	On H	On M
Val 3	Val 4	Val 5	Val 6	Val 7	Val 8	Val 9	Val 10
On AM/PM	On_Act	Off H	Off M	Off AM/PM	Off_Act	Repeat	Manula Weekday
Val 11	Val 12	Val 13	Check Sum				
Volume	Source	Holiday Apply					

On Timer/Off Timer Separated (Added two Items, Data Length is different)

Header	Command	ID	Data Length	Ack/Nak	r-CMD	Val 1	Val 2
0xAA	0xFF		0x11	'A'	0xA6	On H	On M
Val 3	Val 4	Val 5	Val 6	Val 7	Val 8	Val 9	Val 10
On AM/PM	On_Act	Off H	Off M	Off AM/PM	Off_Act	Repeat_On	Manual WeekdayOn
Val 11	Val 12	Val 13	Val 14	Val 15	Check Sum		
Repeat_Off	Manual Week dayOff	Volume	Source	Holiday Apply			

Val1 ~ Val15 : Same as above

Note : If H/M Time values are 0xFF, Time didn't set in LFD.

● **Nak**

Header	Command	ID	Data Length	Ack/Nak	r-CMD	Val 1	Check Sum
0xAA	0xFF		0x03	'N'	0xA6	ERR	

ERR : Error code that shows what occurred error is

2.1.A7 Clock Control_MFM

- **Function**

Control the device clock as day, hour, min, month year and AM/PM

Note : Depends on the produce spec it will work
 Similar command 0xc5 is exist

- **Get**

Header	Command	ID	Data Length	Check Sum
0xAA	0xA7		0x00	

- **Set**

Header	Command	ID	Data Length	Data 1	Data 2	Data 3	Data 4
0xAA	0xA7		0x07	Day	H Time	M Time	Month
Data 5	Data 6	Data 7	Check Sum				
Year1	Year2	APTime					

Day : Day value to be set on TV/Monitor (1 ~ 31)

Month : Month value to be set on TV/Monitor (1 ~ 12)

Year1 : Year value to be set on TV/Monitor (High Byte)

Year2 : Year value to be set on TV/Monitor (Low Byte)

ex) Current year is 2010.

2010(Dec) → 0x07DA(Hex) => Year1: 0x07, Year2: 0xDA

Hour : Hour value to be set on TV/Monitor (1 ~ 12)

Minute : Minute value to be set on TV/Monitor (0 ~ 59)

AmPm : AM/PM value to be set on TV/Monitor (0 ~ 1)

0x00	PM	0x01	AM
------	----	------	----

- **Ack**

Header	Command	ID	Data Length	Ack/Nak	r-CMD	Val 1	Val 2
0xAA	0xFF		0x09	'A'	0xA7	Day	H Time
Val 3	Val 4	Val 5	Val 6	Val 7	Check Sum		
M Time	Month	Year1	Year2	APTime			

Val 1 ~ Val 7 : Same as above

Note : **Hour**, **Minute** if current time was not set on Monitor, 0xFF

- **Nak**

Header	Command	ID	Data Length	Ack/Nak	r-CMD	Val 1	Check Sum
0xAA	0xFF		0x03	'N'	0xA7	ERR	

ERR : Error code that shows what occurred error is

2.1.A8 Holiday Add/Delete Control

- **Function**

Add/Delete the device holiday schedule with the holiday schedule itself start month/day and end month/day

- **Get**

Not Support

- **Set**

Header	Command	ID	Data Length	Data 1	Data 2	Data 3	Data 4
0xAA	0xA8		0x05	Management command	Month1	Day1	Month2
Data 5	Check Sum						
Day2							

Management Command: Adjust Command Holiday List of Device.

0x00	Add Holiday
0x01	Delete Holiday
0x02	Delete All

Note :

- If param is Delete All, Data 2 ~ Data 5 must be set 0.
- Add Holiday : Add New Holiday Information "Month1/Day1 ~ Month2/Day2".
- Delete Holiday : Delete one Holiday Information "Month1/Day1 ~ Month2/Day2".
- Delete All : Delete All Holiday Information. ("Data2 ~ Data5" must be 0x00.)

- **Ack**

Header	Command	ID	Data Length	Ack/Nak	r-CMD	Val 1	Val 2
0xAA	0xFF		0x07	'A'	0xA8	Management command	Month1
Val 3	Val 4	Val 5	Check Sum				
Day1	Month2	Day2					

Val 1 ~ Val 5 : Same as above

- **Nak**

Header	Command	ID	Data Length	Ack/Nak	r-CMD	Val 1	Check Sum
0xAA	0xFF		0x03	'N'	0xA8	ERR	

ERR : Error code that shows what occurred error is

2.1.A9 Holiday Get Control

- **Function**

Get the device holiday schedule.

Note : Depends on the spec it will be work

- **Get**

[Total Number of Holiday]

Request Total number of Holiday information of device

Header	Command	ID	Data Length	Check Sum
0xAA	0xA9		0x00	

[Each holiday schedule]

Request each holiday schedule

Header	Command	ID	Data Length	Data 1	Check Sum
0xAA	0xA9		0x01	Index	

Index : Index value on Holiday List.

- **Set**

Not Support

- **Ack**

Header	Command	ID	Data Length	Ack/Nak	r-CMD	Val 1	Val 2
0xAA	0xFF		0x07	'A'	0xA9	Index	Month1
Val 3	Val 4	Val 5	Check Sum				
Day1	Month2	Day2					

When the value of Val 2 ~ Val 5 is 0, "Get Holiday" is an ACK, Val 1 is number of Holiday information set on TV/Monitor

When the value of Val 2 ~ Val 5 is 0xFF, requested information of index that doesn't set holiday.

Rule of Ack Command.

Input Type	Index	Month 1	Day 1	Month 2	Day 2
Get Number of Holiday	Total number	0	0	0	0
Index which is set Holiday	Set Index	Month1 (Index's data)	Day1 (Index's data)	Month2 (Index's data)	Day2 (Index's data)
Index which is not set Holiday	Set Index	0xFF	0xFF	0xFF	0xFF

- **Nak**

Header	Command	ID	Data Length	Ack/Nak	r-CMD	Val 1	Check Sum
0xAA	0xFF		0x03	'N'	0xA9	ERR	

ERR : Error code that shows what occurred error is

2.1.AB Timer4 Control

- **Function:**

Control the device timer 4 related things like on timer hour/min/am/pm/on.off, off timer hour/min/am/pm/on.off, repeat, manual weekday setting, on timer volume/source and holiday apply

Note : It is dependent on Product Specifications.

- **Get**

Header	Command	ID	Data Length	Check Sum
0xAA	0xAB		0x00	

- **Set**

On Timer/Off Timer Integrated.

Header	Command	ID	Data Length	Data 1	Data 2	Data 3	Data 4
0xAA	0xAB		0x0D	On H	On M	On AM/PM	On_Act
Data 5	Data 6	Date 7	Data 8	Data 9	Data 10	Data 11	Data 12
Off H	Off M	Off AM/PM	Off_Act	Repeat	Manual Weekday	Volume	Source
Data 13	Check Sum						
Holiday Apply							

On Timer/Off Timer Separated (Added two Items, Data Length is different)

Header	Command	ID	Data Length	Data 1	Data 2	Data 3	Data 4
0xAA	0xAB		0x0F	On H	On M	On AM/PM	On_Act
Data 5	Data 6	Date 7	Data 8	Data 9	Data 10	Data 11	Data 12
Off H	Off M	Off AM/PM	Off_Act	Repeat_On	Manual WeekdayOn	Repeat_Off	Manual WeekdayOff
Data 13	Data 14	Data 15	Check Sum				
Volume	Source	Holiday Apply					

On H : On Time Hour value to be set on TV/Monitor (1 ~ 12)

On M : On Time Minute value to be set on TV/Monitor (0 ~ 59)

On AM/PM : On Time AM/PM value to be set on TV/Monitor (0~1)

0x00	PM	0x01	AM
------	----	------	----

On_Act : On Time Inactivated /Activated to be set on TV/Monitor (0(off)~1(on))

Off H : Off Time Hour value to be set on TV/Monitor (1 ~ 12)

Off M : Off Time Minute value to be set on TV/Monitor (0 ~ 59)

Off AM/PM : Off Time AM/PM value to be set on TV/Monitor (0~1)

0x00	PM	0x01	AM
------	----	------	----

Off_Act : Off Time Inactivated /Activated to be set on TV/Monitor (0(off)~1(on))

Repeat_On/Repeat Off : Repeat value to be set on TV/Monitor (0~5)

0x00	Once	0x01	Everyday
0x02	Mon~Fri	0x03	Mon~Sat
0x04	Sat~Sun	0x05	Manual Weekday

ManualWeekday/ManualWeekdayOn/ManualWeekdayOff : Weekday value to be set on TV/Monitor.

BIT7	BIT6	BIT5	BIT4	BIT3	BIT2	BIT1	BIT0
X	Sat	Fri	Thu	Wed	Tue	Mon	Sun

Note : Don't care for BIT7

Volume : Volume to be set on TV/Monitor.

Source : Source to be set on TV/Monitor.

Note : 0x61, WiDi is not available, 0x62 : Internal/USB, USB

Holiday Apply : Apply or not the Holiday to On/Off Timer4 (0 ~ 3)

0x00	Dont't Apply(Both)	0x01	Apply(Both)
0x02	On Timer4 only Apply	0x03	Off Timer4 only Apply

● **Ack**

On Timer/Off Timer Integrated

Header	Command	ID	Data Length	Ack/Nak	r-CMD	Val 1	Val 2
0xAA	0xFF		0x0F	'A'	0xAB	On H	On M
Val 3	Val 4	Val 5	Val 6	Val 7	Val 8	Val 9	Val 10
On AM/PM	On_Act	Off H	Off M	Off AM/PM	Off_Act	Repeat	Manula Weekday
Val 11	Val 12	Val 13	Check Sum				
Volume	Source	Holiday Apply					

On Timer/Off Timer Separated (Added two Items, Data Length is different)

Header	Command	ID	Data Length	Ack/Nak	r-CMD	Val 1	Val 2
0xAA	0xFF		0x11	'A'	0xAB	On H	On M
Val 3	Val 4	Val 5	Val 6	Val 7	Val 8	Val 9	Val 10
On AM/PM	On_Act	Off H	Off M	Off AM/PM	Off_Act	Repeat_On	Manual WeekdayOn
Val 11	Val 12	Val 13	Val 14	Val 15	Check Sum		
Repeat_Off	Manual Week dayOff	Volume	Source	Holiday Apply			

Val1 ~ Val15 : Same as above

Note : If H/M Time values are 0xFF, Time didn't set in LFD.

● **Nak**

Header	Command	ID	Data Length	Ack/Nak	r-CMD	Val 1	Check Sum
0xAA	0xFF		0x03	'N'	0xAB	ERR	

ERR : Error code that shows what occurred error is

2.1.AC Timer5 Control

- **Function:**

Control the device timer 5 related things like on timer hour/min/am/pm/on.off, off timer hour/min/am/pm/on.off, repeat, manual weekday setting, ontimer volume/source and holiday apply

Note : It is dependent on Product Specifications.

- **Get**

Header	Command	ID	Data Length	Check Sum
0xAA	0xAC		0x00	

- **Set**

On Timer/Off Timer Integrated.

Header	Command	ID	Data Length	Data 1	Data 2	Data 3	Data 4
0xAA	0xAC		0x0D	On H	On M	On AM/PM	On_Act
Data 5	Data 6	Date 7	Data 8	Data 9	Data 10	Data 11	Data 12
Off H	Off M	Off AM/PM	Off_Act	Repeat	Manual Weekday	Volume	Source
Data 13	Check Sum						
Holiday Apply							

On Timer/Off Timer Separated (Added two Items, Data Length is different)

Header	Command	ID	Data Length	Data 1	Data 2	Data 3	Data 4
0xAA	0xAC		0x0F	On H	On M	On AM/PM	On_Act
Data 5	Data 6	Date 7	Data 8	Data 9	Data 10	Data 11	Data 12
Off H	Off M	Off AM/PM	Off_Act	Repeat_On	Manual WeekdayOn	Repeat_Off	Manual WeekdayOff
Data 13	Data 14	Data 15	Check Sum				
Volume	Source	Holiday Apply					

On H : On Time Hour value to be set on TV/Monitor (1 ~ 12)

On M : On Time Minute value to be set on TV/Monitor (0 ~ 59)

On AM/PM : On Time AM/PM value to be set on TV/Monitor (0~1)

0x00	PM	0x01	AM
------	----	------	----

On_Act : On Time Inactivated /Activated to be set on TV/Monitor (0(off)~1(on))

Off H : Off Time Hour value to be set on TV/Monitor (1 ~ 12)

Off M : Off Time Minute value to be set on TV/Monitor (0 ~ 59)

Off AM/PM : Off Time AM/PM value to be set on TV/Monitor (0~1)

0x00	PM	0x01	AM
------	----	------	----

Off_Act : Off Time Inactivated /Activated to be set on TV/Monitor (0(off)~1(on))

Repeat_On/Repeat Off : Repeat value to be set on TV/Monitor (0~5)

0x00	Once	0x01	Everyday
0x02	Mon~Fri	0x03	Mon~Sat
0x04	Sat~Sun	0x05	Manual Weekday

ManualWeekday/ManualWeekdayOn/ManualWeekdayOff : Weekday value to be set on TV/Monitor.

BIT7	BIT6	BIT5	BIT4	BIT3	BIT2	BIT1	BIT0
X	Sat	Fri	Thu	Wed	Tue	Mon	Sun

Note : Don't care for BIT7

Volume : Volume to be set on TV/Monitor.

Source : Source to be set on TV/Monitor.

Note : 0x61, WiDi is not available, 0x62 : Internal/USB, USB

Holiday Apply : Apply or not the Holiday to On/Off Timer5 (0 ~ 3)

0x00	Dont't Apply(Both)	0x01	Apply(Both)
0x02	On Timer5 only Apply	0x03	Off Timer5 only Apply

● **Ack**

On Timer/Off Timer Integrated

Header	Command	ID	Data Length	Ack/Nak	r-CMD	Val 1	Val 2
0xAA	0xFF		0x0F	'A'	0xAC	On H	On M
Val 3	Val 4	Val 5	Val 6	Val 7	Val 8	Val 9	Val 10
On AM/PM	On_Act	Off H	Off M	Off AM/PM	Off_Act	Repeat	Manula Weekday
Val 11	Val 12	Val 13	Check Sum				
Volume	Source	Holiday Apply					

On Timer/Off Timer Separated (Added two Items, Data Length is different)

Header	Command	ID	Data Length	Ack/Nak	r-CMD	Val 1	Val 2
0xAA	0xFF		0x11	'A'	0xAC	On H	On M
Val 3	Val 4	Val 5	Val 6	Val 7	Val 8	Val 9	Val 10
On AM/PM	On_Act	Off H	Off M	Off AM/PM	Off_Act	Repeat_On	Manual WeekdayOn
Val 11	Val 12	Val 13	Val 14	Val 15	Check Sum		
Repeat_Off	Manual Week dayOff	Volume	Source	Holiday Apply			

Val1 ~ Val15 : Same as above

Note : If H/M Time values are 0xFF, Time didn't set in LFD.

● **Nak**

Header	Command	ID	Data Length	Ack/Nak	r-CMD	Val 1	Check Sum
0xAA	0xFF		0x03	'N'	0xAC	ERR	

ERR : Error code that shows what occurred error is

2.1.AD Timer6 Control

- **Function:**

Control the device timer 6 related things like on timer hour/min/am.pm/on.off, off timer hour/min/am.pm/on.off, repeat, manual weekday setting, ontimer volume/source and holiday apply

Note : It is dependent on Product Specifications.

- **Get**

Header	Command	ID	Data Length	Check Sum
0xAA	0xAD		0x00	

- **Set**

On Timer/Off Timer Integrated.

Header	Command	ID	Data Length	Data 1	Data 2	Data 3	Data 4
0xAA	0xAD		0x0D	On H	On M	On AM/PM	On_Act
Data 5	Data 6	Date 7	Data 8	Data 9	Data 10	Data 11	Data 12
Off H	Off M	Off AM/PM	Off_Act	Repeat	Manual Weekday	Volume	Source
Data 13	Check Sum						
Holiday Apply							

On Timer/Off Timer Separated (Added two Items, Data Length is different)

Header	Command	ID	Data Length	Data 1	Data 2	Data 3	Data 4
0xAA	0xAD		0x0F	On H	On M	On AM/PM	On_Act
Data 5	Data 6	Date 7	Data 8	Data 9	Data 10	Data 11	Data 12
Off H	Off M	Off AM/PM	Off_Act	Repeat_On	Manual WeekdayOn	Repeat_Off	Manual WeekdayOff
Data 13	Data 14	Data 15	Check Sum				
Volume	Source	Holiday Apply					

On H : On Time Hour value to be set on TV/Monitor (1 ~ 12)

On M : On Time Minute value to be set on TV/Monitor (0 ~ 59)

On AM/PM : On Time AM/PM value to be set on TV/Monitor (0~1)

0x00	PM	0x01	AM
------	----	------	----

On_Act : On Time Inactivated /Activated to be set on TV/Monitor (0(off)~1(on))

Off H : Off Time Hour value to be set on TV/Monitor (1 ~ 12)

Off M : Off Time Minute value to be set on TV/Monitor (0 ~ 59)

Off AM/PM : Off Time AM/PM value to be set on TV/Monitor (0~1)

0x00	PM	0x01	AM
------	----	------	----

Off_Act : Off Time Inactivated /Activated to be set on TV/Monitor (0(off)~1(on))

Repeat_On/Repeat Off : Repeat value to be set on TV/Monitor (0~5)

0x00	Once	0x01	Everyday
0x02	Mon~Fri	0x03	Mon~Sat
0x04	Sat~Sun	0x05	Manual Weekday

ManualWeekday/ManualWeekdayOn/ManualWeekdayOff : Weekday value to be set on TV/Monitor.

BIT7	BIT6	BIT5	BIT4	BIT3	BIT2	BIT1	BIT0
X	Sat	Fri	Thu	Wed	Tue	Mon	Sun

Note : Don't care for BIT7

Volume : Volume to be set on TV/Monitor.

Source : Source to be set on TV/Monitor.

Note : 0x61, WiDi is not available, 0x62 : Internal/USB, USB

Holiday Apply : Apply or not the Holiday to On/Off Timer6 (0 ~ 3)

0x00	Dont't Apply(Both)	0x01	Apply(Both)
0x02	On Timer1 only Apply	0x03	Off Timer1 only Apply

● **Ack**

On Timer/Off Timer Integrated

Header	Command	ID	Data Length	Ack/Nak	r-CMD	Val 1	Val 2
0xAA	0xFF		0x0F	'A'	0xAD	On H	On M
Val 3	Val 4	Val 5	Val 6	Val 7	Val 8	Val 9	Val 10
On AM/PM	On_Act	Off H	Off M	Off AM/PM	Off_Act	Repeat	Manula Weekday
Val 11	Val 12	Val 13	Check Sum				
Volume	Source	Holiday Apply					

On Timer/Off Timer Separated (Added two Items, Data Length is different)

Header	Command	ID	Data Length	Ack/Nak	r-CMD	Val 1	Val 2
0xAA	0xFF		0x11	'A'	0xAD	On H	On M
Val 3	Val 4	Val 5	Val 6	Val 7	Val 8	Val 9	Val 10
On AM/PM	On_Act	Off H	Off M	Off AM/PM	Off_Act	Repeat_On	Manual WeekdayOn
Val 11	Val 12	Val 13	Val 14	Val 15	Check Sum		
Repeat_Off	Manual Week dayOff	Volume	Source	Holiday Apply			

Val1 ~ Val15 : Same as above

Note : If H/M Time values are 0xFF, Time didn't set in LFD.

● **Nak**

Header	Command	ID	Data Length	Ack/Nak	r-CMD	Val 1	Check Sum
0xAA	0xFF		0x03	'N'	0xAD	ERR	

ERR : Error code that shows what occurred error is

2.1.AE Timer7 Control

- **Function:**

Control the device timer 7 related things like on timer hour/min/am.pm/on.off, off timer hour/min/am.pm/on.off, repeat, manual weekday setting, ontimer volume/source and holiday apply

Note : It is dependent on Product Specifications.

- **Get**

Header	Command	ID	Data Length	Check Sum
0xAA	0xAE		0x00	

- **Set**

On Timer/Off Timer Integrated.

Header	Command	ID	Data Length	Data 1	Data 2	Data 3	Data 4
0xAA	0xAE		0x0D	On H	On M	On AM/PM	On_Act
Data 5	Data 6	Date 7	Data 8	Data 9	Data 10	Data 11	Data 12
Off H	Off M	Off AM/PM	Off_Act	Repeat	Manual Weekday	Volume	Source
Data 13	Check Sum						
Holiday Apply							

On Timer/Off Timer Separated (Added two Items, Data Length is different)

Header	Command	ID	Data Length	Data 1	Data 2	Data 3	Data 4
0xAA	0xAE		0x0F	On H	On M	On AM/PM	On_Act
Data 5	Data 6	Date 7	Data 8	Data 9	Data 10	Data 11	Data 12
Off H	Off M	Off AM/PM	Off_Act	Repeat_On	Manual WeekdayOn	Repeat_Off	Manual WeekdayOff
Data 13	Data 14	Data 15	Check Sum				
Volume	Source	Holiday Apply					

On H : On Time Hour value to be set on TV/Monitor (1 ~ 12)

On M : On Time Minute value to be set on TV/Monitor (0 ~ 59)

On AM/PM : On Time AM/PM value to be set on TV/Monitor (0~1)

0x00	PM	0x01	AM
------	----	------	----

On_Act : On Time Inactivated /Activated to be set on TV/Monitor (0(off)~1(on))

Off H : Off Time Hour value to be set on TV/Monitor (1 ~ 12)

Off M : Off Time Minute value to be set on TV/Monitor (0 ~ 59)

Off AM/PM : Off Time AM/PM value to be set on TV/Monitor (0~1)

0x00	PM	0x01	AM
------	----	------	----

Off_Act : Off Time Inactivated /Activated to be set on TV/Monitor (0(off)~1(on))

Repeat_On/Repeat Off : Repeat value to be set on TV/Monitor (0~5)

0x00	Once	0x01	Everyday
0x02	Mon~Fri	0x03	Mon~Sat
0x04	Sat~Sun	0x05	Manual Weekday

ManualWeekday/ManualWeekdayOn/ManualWeekdayOff : Weekday value to be set on TV/Monitor.

BIT7	BIT6	BIT5	BIT4	BIT3	BIT2	BIT1	BIT0
X	Sat	Fri	Thu	Wed	Tue	Mon	Sun

Note : Don't care for BIT7

Volume : Volume to be set on TV/Monitor.

Source : Source to be set on TV/Monitor.

Note : 0x61, WiDi is not available, 0x62 : Internal/USB, USB

Holiday Apply : Apply or not the Holiday to On/Off Timer7 (0 ~ 3)

0x00	Dont't Apply(Both)	0x01	Apply(Both)
0x02	On Timer1 only Apply	0x03	Off Timer1 only Apply

● **Ack**

On Timer/Off Timer Integrated

Header	Command	ID	Data Length	Ack/Nak	r-CMD	Val 1	Val 2
0xAA	0xFF		0x0F	'A'	0xAE	On H	On M
Val 3	Val 4	Val 5	Val 6	Val 7	Val 8	Val 9	Val 10
On AM/PM	On_Act	Off H	Off M	Off AM/PM	Off_Act	Repeat	Manula Weekday
Val 11	Val 12	Val 13	Check Sum				
Volume	Source	Holiday Apply					

On Timer/Off Timer Separated (Added two Items, Data Length is different)

Header	Command	ID	Data Length	Ack/Nak	r-CMD	Val 1	Val 2
0xAA	0xFF		0x11	'A'	0xAE	On H	On M
Val 3	Val 4	Val 5	Val 6	Val 7	Val 8	Val 9	Val 10
On AM/PM	On_Act	Off H	Off M	Off AM/PM	Off_Act	Repeat_On	Manual WeekdayOn
Val 11	Val 12	Val 13	Val 14	Val 15	Check Sum		
Repeat_Off	Manual Week dayOff	Volume	Source	Holiday Apply			

Val1 ~ Val15 : Same as above

Note : If H/M Time values are 0xFF, Time didn't set in LFD.

● **Nak**

Header	Command	ID	Data Length	Ack/Nak	r-CMD	Val 1	Check Sum
0xAA	0xFF		0x03	'N'	0xAE	ERR	

ERR : Error code that shows what occurred error is

2.1.AF Edit Name Control

- **Function**

Control the device source device type which is provided by source edit menu

Note : Depends on the product spec, it will work

- **Get**

Header	Command	ID	Data Length	Check Sum
0xAA	0xAF		0x00	

- **Set**

Header	Command	ID	Data Length	Data 1	Check Sum
0xAA	0xAF		0x01	Ename	

Ename : TV 가 설정할 Edit Name Code

0x00	NONE	0x10	DMA
0x01	VCR	0x11	DVD Receiver
0x02	DVD	0x12	HD STB
0x03	Cable STB	0x13	DVD Combo
0x04	Satellite STB	0x14	DHR
0x05	PVR STB		
0x06	AV Receiver		
0x07	Game		
0x08	Camcorder		
0x09	PC		
0x0A	DVI PC		
0x0B	DVI Devices		
0x0C	TV		
0x0D	IPTV		
0x0E	Blu-ray		
0x0F	HD DVD		

- **Ack**

Header	Command	ID	Data Length	Ack/Nak	r-CMD	Val 1	Check Sum
0xAA	0xFF		0x03	'A'	0xAF	Ename	

Ename : Same as Above

- **Nak**

Header	Command	ID	Data Length	Ack/Nak	r-CMD	Val 1	Check Sum
0xAA	0xFF		0x03	'N'	0xAF	ERR	

ERR : Error code that shows what occurred error is

2.1.B0 Virtual Remote Control

- **Function**

Create the device virtual remote control event.

Note : It works same as remote control event

- **Get**

Not Support

- **Set**

Header	Command	ID	Data Length	Val 1	Check Sum
0xAA	0xB0		0x01	KeyCode	

KeyCode

-	-	0x01	KEY_SOURCE
0x02	KEY_POWER	-	-
0x04	KEY_1	0x05	KEY_2
0x06	KEY_3	0x07	KEY_VOLUME_UP
0x08	KEY_4	0x09	KEY_5
0x0A	KEY_6	0x0B	KEY_VOLUME_DOWN
0x0C	KEY_7	0x0D	KEY_8
0x0E	KEY_9	0x0F	KEY_MUTE
0x10	KEY_CHANNEL_DOWN	0x11	KEY_0
0x12	KEY_CHANNEL_UP	-	-
0x14	KEY_GREEN	-	-
0x15	KEY_YELLOW	0x16	KEY_CYAN
0x1A	KEY_MENU	-	-
-	-	0x1F	KEY_DISPLAY (or KEY_INFO)
-	-	0x23	KEY_DIGIT
0x24	KEY_PIP_TV_VIDEO (or KEY_BLANK)	-	-
-	-	0x2D	KEY_EXIT
0x30	Magicinfo	-	-
-	-	0x45	KEY_REW
0x46	KEY_STOP	0x47	KEY_PLAY
0x48	KEY_FF	-	-
0x4A	KEY_PAUSE	0x4B	KEY_TOOLS
0x58	KEY_RETURN	-	-
-	-	0x5B	KEY_MAGICINFO_LITE
0x60	KEY_CURSOR_UP	0x61	KEY_CURSOR_DOWN
0x62	KEY_CURSOR_RIGHT	-	-
-	-	0x65	KEY_CURSOR_LEFT
0x68	KEY_ENTER	-	-

0x6C	KEY_RED	-	-
-	-	0x77	KEY_LOCK
-	-	0x79	KEY_CONTENT
0x98	DISCRET_POWER_OFF	-	-
-	-	0x9F	KEY_3D

Note : In a certain model, 0x79 content key works as Home and 0x1f Display key works as Info

- **Ack**

Header	Command	ID	Data Length	Ack/Nak	r-CMD	Val 1	Check Sum
0xAA	0xFF		0x03	'A'	0xB0	KeyCode	

KeyCode : Same as above

- **Nak**

Header	Command	ID	Data Length	Ack/Nak	r-CMD	Val 1	Check Sum
0xAA	0xFF		0x03	'N'	0xB0	ERR	

ERR : Error code that shows what occurred error is

2.1.B1 Display Port Daisy Chain

- **Function**

Control the device display port daisy chain mode

- **Get**

Header	Command	ID	Data Length	Check Sum
0xAA	0xB1		0x00	

- **Set**

Header	Command	ID	Data Length	Data 1	Check Sum
0xAA	0xB1		0x01	Value	

Value : The Value of set for Display Port Daisy Chain.

0x00	Clone	0x01	Expand
------	-------	------	--------

- **Ack**

Header	Command	ID	Data Length	Ack/Nak	r-CMD	Val 1	Check Sum
0xAA	0xFF		0x03	'A'	0xB1	Value	

Value : Same as above

- **Nak**

Header	Command	ID	Data Length	Ack/Nak	r-CMD	Val 1	Check Sum
0xAA	0xFF		0x03	'N'	0xB1	ERR	

ERR : Error code that shows what occurred error is.

2.1.B2 3Screen/4Screen Mode Control

● Function

Control the device 3screen/4screen related things like on/off, sound, screen size, main screen size, sub screen source

Note : It will not work on PIP on status.

When 2/4 screen is enabled, picture size is not work

Depends on each model spec it will be supported or not.

And depends on the product spec some of data will not work

● Get

Header	Command	ID	Data Length	Check Sum
0xAA	0xB2		0x00	

● Set

[Type1] 3Screen

Header	Command	ID	Data Length	Data 1	Data 2	Data 3	Data 4
0xAA	0xB2		0x08	3 Screen On/Off	Sound Select	Screen Size	Main Screen Picture Size
Data 5	Data 6	Data 7	Data 8	Check Sum			
Sub Screen 1 Source	Sub Screen 1 Picture Size	Sub Screen 2 Source	Sub Screen 2 Picture Size				

[Type2] 4Screen

Header	Command	ID	Data Length	Data 1	Data 2	Data 3	Data 4
0xAA	0xB2		0x0A	4 Screen On/Off	Sound Select	Screen Size	Main Screen Picture Size
Data 5	Data 6	Data 7	Data 8	Data 9	Data 10	Check Sum	
Sub Screen 1 Source	Sub Screen 1 Picture Size	Sub Screen 2 Source	Sub Screen 2 Picture Size	Sub Screen 3 Source	Sub Screen 3 Picture Size		

[Type3] 4Screen without picture size

Header	Command	ID	Data Length	Data 1	Data 2	Data 3	Data 4
0xAA	0xB2		0x06	4 Screen On/Off	Sound Select	Sub Screen 0 Source	Sub Screen 1 Source
Data 5	Data 6	Check Sum					
Sub Screen 2 Source	Sub Screen 3 Source						

3Screen/4Screen On/Off : Enable or disable the divided screen

0x00	Divided screen Off	0x01	3Screen On
0x02	4Screen On	-	-

Sound Select : Select the sound from each screen

0x00	Main Screen	0x01	Sub Screen1
0x02	Sub Screen2	0x03	Sub Screen3

Note : When Video Conference Sound Mode is on, it will not work but will not answer as NAK

Screen Size : Screen ratio between main and sub

0x00	Mode1	0x01	Mode2
0x02	Mode3	0x03	Mode4 (960:960)
0x04	Mode5 (1440:480)	0x05	Mode6 (1280:640)

Sub Screen(0, 1,2,3) Source : 각 Sub Screen 에 해당하는 Source 값(Refer 0x14 command for detail)

Note : For the Type3, Each sub screen screen position is like bellowed

Sub Screen 0	Sub Screen 1
Sub Screen 2	Sub Screen 3

Main(Sub1,2,3) Screen Picture Size : Picture size value of each screen

0x09	Full(Screen Fit)	0x20	Original(Aspect Ratio)
------	------------------	------	------------------------

● Ack

[Type1] 3Screen

Header	Command	ID	Data Length	Ack/Nak	r-CMD	Val 1	Val 2
0xAA	0xFF			0x0A	'A'	0xB2	3 Screen On/Off
Val 3	Val 4	Val 5	Val 6	Val 7	Val 8	Check Sum	
Screen Size	Main Screen Picture Size	Sub Screen1 Source	Sub Screen1 Picture Size	Sub Screen2 Source	Sub Screen2 Picture Size		

[Type2] 4Screen

Header	Command	ID	Data Length	Ack/Nak	r-CMD	Val 1	Val 2
0xAA	0xFF			0x0C	'A'	0xB2	4 Screen On/Off
Val 3	Val 4	Val 5	Val 6	Val 7	Val 8	Val 9	Val 10
Screen Size	Main Screen Picture Size	Sub Screen 1 Source	Sub Screen 1 Picture Siz	Sub Screen 2 Source	Sub Screen 2 Picture Siz	Sub Screen 3 Source	Sub Screen 3 Picture Siz
Check Sum							

[Type3] 4Screen without picture size

Header	Command	ID	Data Length	Ack/Nak	r-CMD	Val 1	Val 2
0xAA	0xFF			0x08	'A'	0xB2	4 Screen On/Off
Val 3	Val 4	Val 5	Val 6	Check Sum			
Sub Screen 0 Source	Sub Screen 1 Source	Sub Screen 2 Source	Sub Screen 3 Source				

3 Screen/4 Screen On/Off, Sound Select, Screen Size, Sub Screen(0, 1,2,3) Source, Main(Sub1,2,3)

Screen Picture Size : Same as above

Note : If the return data is 0xff, it means invalid

- Nak

Header	Command	ID	Data Length	Ack/Nak	r-CMD	Val 1	Check Sum
0xAA	0xFF		0x03	'N'	0xB2	ERR	

ERR : Error code that shows what occurred error is.

2.1.B3 Video Conference Sound Mode Control

- **Function**

Control the device video conference sound mode

Note : In case of PIP on and this conference Sound on, PIP sound select will not work

When S.Sound mode set off, PIP sound will change as it's last memory value

Conference Sound will support last memory

- **Get**

Header	Command	ID	Data Length	Check Sum
0xAA	0xB3		0x00	

- **Set**

Header	Command	ID	Data Length	Data 1	Check Sum
0xAA	0xB3		0x01	Conference Sound	

Conference Sound : Video Conference Sound On/Off set Value.

0x00	Video Conference Sound Off	0x01	Video Conference Sound On
------	----------------------------	------	---------------------------

- **Ack**

Header	Command	ID	Data Length	Ack/Nak	r-CMD	Val 1	Check Sum
0xAA	0xFF		0x03	'A'	0xB3	Conference Sound	

Conference Sound : Same as above

- **Nak**

Header	Command	ID	Data Length	Ack/Nak	r-CMD	Val 1	Check Sum
0xAA	0xFF		0x03	'N'	0xB3	ERR	

ERR : Error code that shows what occurred error is.

2.1.B5 Network Standby Control

- **Function**

Control the device network standby mode

- **Get**

Header	Command	ID	Data Length	Check Sum
0xAA	0xB5		0x00	

- **Set**

Header	Command	ID	Data Length	Data 1	Check Sum
0xAA	0xB5		0x01	Network Standby On/Off	

Network Standby On/Off : Network Standby Value

0x00	Network Standby Off	0x01	Network Standby On
------	---------------------	------	--------------------

- **Ack**

Header	Command	ID	Data Length	Ack/Nak	r-CMD	Val 1	Check Sum
0xAA	0xFF		0x03	'A'	0xB5	Network Standby On/Off	

Value : Same as above

- **Nak**

Header	Command	ID	Data Length	Ack/Nak	r-CMD	Val 1	Check Sum
0xAA	0xFF		0x03	'N'	0xB5	ERR	

ERR : Error code that shows what occurred error is.

2.1.B6 DST (Daylight Saving Time) Control

● Function

Control the device manual DST functionality things like on/off, start/end date, start/end time and offset time

● Get

Header	Command	ID	Data Length	Check Sum
0xAA	0xB6		0x00	

● Set

Header	Command	ID	Data Length	Data 1	Data 2	Data 3	Data 4
0xAA	0xB6		0x0C	DST On/Off	Month of Start Date	Week Info of Start Date	Weekday Info of Start Date
Data 5	Data 6	Data 7	Data 8	Data 9	Data 10	Data 11	Data 12
Time H of Start date	Time M of Start date	Month of End Date	Week Info of End Date	Weekday Info of End Date	Time H of End date	Time M of End date	Time Off Set
Check Sum							

DST On/Off : DST Value

Tunerless Model		Tuner supported Model	
0x00	DST Off	0x00	DST Off
0x01	--	0x01	Auto
0x02	DST On	0x02	Manual

Note : Data2 ~12 are valid in case of DST On or Manual

Month of Start Date, Month of End Date : Month in which DST start/end (0x00 : Jan ~ 0x0b : Dec)

Week Info of Start Date, Week Info of End Date : Order of the day of the week in which DST start/end.

0x00	1 st	0x01	2 nd
0x02	3 rd	0x03	4 th
0x04	Last		

Weekday Info of Start Date, Weekday Info of End Date : Day of week in which DST start/end (0x00 : Mon ~ 0x06 : Sun)

Time H of Start date, Time H of End date : Hours of the time that DST start/end (0 ~ 23)

Time M of Start date, Time M of End date : Minutes of the time that DST start/end (0 ~ 59)

Time Off Set : Value of Time offset

0x00	+1:00	0x01	+2:00
------	-------	------	-------

● Ack

Header	Command	ID	Data Length	Ack/Nak	r-CMD	Val 1	Val 2
0xAA	0xFF		0x0F	'A'	0xB6	DST On/Off	Month of Start Date
Val 3	Val 4	Val 5	Val 6	Val 7	Val 8	Val 9	Val 10
Value1 of Day on	Value2 of Day on	Time H of Start date	Time M of Start date	Month of End Date	Value1 of Day on End	Value2 of Day on End	Time H of End date

Start Date	Start Date				Date	Date	
Val 11	Val 12	Val 13	Check Sum				
Time M of End date	Time Off Set	Tuner/Tunerless Model					

Tuner/Tunerless Model : Tuner – 1, Tunerless – 0

- **Nak**

Header	Command	ID	Data Length	Ack/Nak	r-CMD	Val 1	Check Sum
0xAA	0xFF		0x03	'N'	0xB6	ERR	

ERR : Error code that shows what occurred error is.

2.1.B7 Custom PIP Control

● Function

Control the device custom PIP related things like horizontal/vertical position and horizontal/vertical size

Note : It update custom PIP related things and when PIP mode is set as custom it will work

● Get

Header	Command	ID	Data Length	Check Sum
0xAA	0xB7		0x00	

● Set

Header	Command	ID	Data Length	Data 1	Data 2	Data 3	Data 4
0xAA	0xB7		0x08	H Position		V Position	
Data 5	Data 6	Data 7	Data 8	Check Sum			
H Size		V Size					

H Position : Custom PIP horizontal start position

V Position : Custom PIP vertical start position

H Size : Custom PIP horizontal size

V Size : Custom PIP vertical size

Note :

- The PIP Start Position and Size can not over panel H, V size
- H/V Size : 512 * 288 ~ 1632 * 918 (H Interval : 160 pixel, V Interval : 90 pixel)
512*288, 672*378, 832*468, 992*558, 1152*648, 1312*738, 1472*828, 1632*918
- H/V Position : Interval 10 Pixel

● Ack

Header	Command	ID	Data Length	Ack/Nak	r-CMD	Val 1	Val 2
0xAA	0xFF		0x0A	'A'	0xB7	H Position	
Val 3	Val 4	Val 5	Val 6	Val 7	Val 8	Check Sum	
V Position		H Size		V Size			

H Position, V Position, H Size, V Size : Same as above

● Nak

Header	Command	ID	Data Length	Ack/Nak	r-CMD	Val 1	Check Sum
0xAA	0xFF		3	'N'	0xB7	ERR	

ERR : Error code that shows what occurred error is.

2.1.B8 Auto ID Setting Status Control

- **Function**

Control the device auto ID setting status

- **Get**

Header	Command	ID	Data Length	Check Sum
0xAA	0xB8		0x00	

- **Set**

Header	Command	ID	Data Length	Data 1	Check Sum
0xAA	0xB8		0x01	Status	

Status : value of Auto ID settings status.

0x00	Auto ID Setting START	0x01	Auto ID Setting END
------	-----------------------	------	---------------------

- **Ack**

Header	Command	ID	Data Length	Ack/Nak	r-CMD	Val 1	Check Sum
0xAA	0xFF		0x03	'A'	0xB8	Status	

Value : Same as above

- **Nak**

Header	Command	ID	Data Length	Ack/Nak	r-CMD	Val 1	Check Sum
0xAA	0xFF		0x03	'N'	0xB8	ERR	

ERR : Error code that shows what occurred error is

2.1.B9 Display ID Information

- **Function**

Display/Hide the device MDC ID

- **Get**

Not Supported

- **Set**

Header	Command	ID	Data Length	Data 1	Check Sum
0xAA	0xB9		0x01	ID Display On/Off	

ID Display On/Off : Monitor ID

0x00	Monitor ID Display Off	0x01	Monitor ID Display On
------	------------------------	------	-----------------------

- **Ack**

Header	Command	ID	Data Length	Ack/Nak	r-CMD	Val 1	Check Sum
0xAA	0xFF		0x03	'A'	0xB9	ID Display On/Off	

Value : Same as above

- **Nak**

Header	Command	ID	Data Length	Ack/Nak	r-CMD	Val 1	Check Sum
0xAA	0xFF		0x03	'N'	0xB9	ERR	

ERR : Error Code which is displayed when error is occurred.

2.1.C5 Clock Control_MFM (Second field can be set)

- **Function**

Control the device clock as day, hour, min, month year and AM/PM

Note : It will work on the signage device which is product after 13year
 Similar command 0xc5 is exist

- **Get**

Header	Command	ID	Data Length	Check Sum
0xAA	0xC5		0x00	

- **Set**

Header	Command	ID	Data Length	Val 1	Val 2	Val 3	Val 4
0xAA	0xC5		0x08	Day	H Time	M Time	S Time
Val 5	Val 6	Val 7	Val 8	Check Sum			
Month	Year		APTime				

Day : Day value to be set on TV/Monitor (1 ~ 31)

H Time : Hour value to be set on TV/Monitor (1 ~ 12)

M Time : Minute value to be set on TV/Monitor (0 ~ 59)

S Time : Second value to be set on TV/Monitor (0 ~ 59)

Month : Month value to be set on TV/Monitor (1 ~ 12)

Year : Year value to be set on TV/Monitor

ex) Current year is 2010.

2010(Dec) → 0x07DA(Hex) => Year1: 0x07, Year2: 0xDA

APTime : AM/PM value to be set on TV/Monitor (0 ~ 1)

0x00	PM	0x01	AM
------	----	------	----

- **Ack**

Header	Command	ID	Data Length	Ack/Nak	r-CMD	Val 1	Val 2
0xAA	0xFF		0x0A	'A'	0xC5	Day	H Time
Val 3	Val 4	Val 5	Val 6	Val 7	Val 8	Check Sum	
M Time	S Time	Month	Year		APTime		

Day, H Time, M Time, S Time, Month, Year, APTime : Same as above

Note : **Hour, Minute** if current time was not set on device it will be 0xFF

- **Nak**

Header	Command	ID	Data Length	Ack/Nak	r-CMD	Val 1	Check Sum
0xAA	0xFF		0x03	'N'	0xC5	ERR	

ERR : Error code that shows what occurred error is

2.1.C6 EcoSolution control in MDC Protocol

- **Function**

Control the features of OnScreen Display Menu

- **Working Condition**

– Depends on each model spec it will be supported or not

- **Sub Command Table**

Sub CMD	Function	Sub CMD	Function
0x81	Auto Power Off	0x82	Brightness Limit

2.1.C6.81 Auto Power Off

- **Function**

Control the device auto power off mode which makes auto power off when there no user interaction for a certain time

Note : Depends on each model spec it will be supported or not

- **Get**

Header	Command	ID	Data Length	Sub CMD	Check Sum
0xAA	0xC6		0x01	0x81	

- **Set**

Header	Command	ID	Data Length	Sub Cmd	Data 1	Check Sum
0xAA	0xC6		0x02	0x81	AutoPower Off	

AutoPowerOff

0x00	Off	0x01	4 Hour(On)
0x02	6 Hour	0x03	8 Hour
0x04	16 Hour	-	-

Note : If the model has On/Off value only, Data 0 is Off and Data 1 is On.

- **Ack**

Header	Command	ID	Data Length	Ack/Nak	r-CMD	r-SUBCMD	Val 1
0xAA	0xFF		4	'A'	0xC6	0x81	AutoPower Off
Check Sum							

AutoPowerOff: Same as above

- **Nak**

Header	Command	ID	Data Length	Ack/Nak	r-CMD	r-SUBCMD	Val 1
0xAA	0xFF		4	'N'	0xC6	0x81	ERR
Check Sum							

ERR: The error code indicating which error occurred.

2.1.C6.82 Brightness Limit

- **Function**

Control the device brightness limit mode which is limit the maximum brightness for energy saving

Note : Depends on each model spec it will be supported or not

- **Get**

Header	Command	ID	Data Length	Sub CMD	Check Sum
0xAA	0xc6		0x01	0x82	

- **Set**

Header	Command	ID	Data Length	Sub Cmd	Data 1	Check Sum
0xAA	0xC6		0x02	0x82	Brightness Limit	

Brightness Limit

0x00	Off	0x01	On
------	-----	------	----

- **Ack**

Header	Command	ID	Data Length	Ack	r-CMD	Sub CMD	Val1
0xAA	0xFF		0x04	'A'	0xc6	0x82	Brightness Limit
Check Sum							

Brightness Limit: Same as above

- **Nak**

Header	Command	ID	Data Length	Ack/Nak	r-CMD	r-SUBCMD	Val 1
0xAA	0xFF		4	'N'	0xc6	0x82	ERR
Check Sum							

ERR : Error code that shows what occurred error is

2.1.C7 Control Launcher by MDC Protocol

- **Function**

Control the features of OnScreen Display Menu

- **Working Condition**

– Depends on each model spec it will be supported or not

- **Sub Command Table**

Sub CMD	Function	Sub CMD	Function
0x81	Play Via Mode	-	-

2.1.C7.81 Play Via Mode

- **Function**

Control the device play via mode which set the player

Note : Depends on each model spec it will be supported or not

- **Get**

Header	Command	ID	Data Length	Sub CMD	Check Sum
0xAA	0xC7		0x01	0x81	

- **Set**

Header	Command	ID	Data Length	Sub Cmd	Data 1	Check Sum
0xAA	0xC7		0x02	0x81	Play Via Mode	

Play Via Mode

0x00	MagicInfo	0x01	URL Launcher
0x02	MagicIWB	-	-

Note : When the Magicinfo S or MagicIWB or URL Launcher is running, this command will not run.

- **Ack**

Header	Command	ID	Data Length	Ack/Nak	r-CMD	r-SUBCMD	Val 1
0xAA	0xFF		4	'A'	0xC7	0x81	Play Via Mode
Check Sum							

Play Via Mode: Same as above

- **Nak**

Header	Command	ID	Data Length	Ack/Nak	r-CMD	r-SUBCMD	Val 1
0xAA	0xFF		4	'N'	0xC7	0x81	ERR
Check Sum							

ERR: The error code indicating which error occurred.

2.1.C7.82 URL Address

- **Function**

Control the device URL of URL launcher

- **Working Condition**

– Depends on each model spec it will be supported or not

- **Get URL Address**

Header	Command	ID	Data Length	Sub CMD	Check Sum
0xAA	0xC7		0x01	0x82	

- **Set URL Address**

Header	Command	ID	Data Length	Sub CMD	Data1	...	DataN
0xAA	0xc7		Variable	0x82	URL Address		
Check Sum							

URL Address : ASCII code data, support 200 characters.

- **Ack**

Header	Command	ID	Data Length	Ack	r-CMD	Sub CMD	Val1
0xAA	0xFF		Variable	'A'	0xc7	0x82	URL Address
Val2	...	ValN	Check Sum	URL Address			

URL Address : Same as above

- **Nak**

Header	Command	ID	Data Length	Ack/Nak	r-CMD	r-SUBCMD	Val 1
0xAA	0xFF		4	'N'	0xC7	0x82	ERR
Check Sum							

ERR: The error code indicating which error occurred.

2.1.C8 OnScreen Display Menu Control

- **Function**

Control the features of OnScreen Display Menu

- **Working Condition**

– Depends on each model spec it will be supported or not

- **Sub Command Table**

Sub CMD	Function	Sub CMD	Function
0x81	Menu Orientation	0x82	Source Content Orientation
0x83	Aspect Ratio	0x84	PIP Orientation
0x85	Menu Size	–	–

2.1.C8.81 Menu Orientation

- **Function**

Control the device menu orientation which set the menu display mode as portrait or landscape

Note : Depends on each model spec it will be supported or not

- **Get**

Header	Command	ID	Data Length	Sub CMD	Check Sum
0xAA	0xC8		0x01	0x81	

- **Set**

Header	Command	ID	Data Length	Sub Cmd	Data 1	Check Sum
0xAA	0xC8		0x02	0x81	Orientation Mode	

Orientation Mode

0x00	Landscape(0)	0x01	Portrait(270)
0x02	180	0x03	90

- **Ack**

Header	Command	ID	Data Length	Ack/Nak	r-CMD	r-SUBCMD	Val 1
0xAA	0xFF		4	'A'	0xC8	0x81	Orientation Mode
Check Sum							

Orientation Mode : Same as above

- **Nak**

Header	Command	ID	Data Length	Ack/Nak	r-CMD	r-SUBCMD	Val 1
0xAA	0xFF		4	'N'	0xC8	0x81	ERR
Check Sum							

ERR: The error code indicating which error occurred.

2.1.C8.82 Source Content Orientation

- **Function**

Control the device source contents orientation which set the source contents display mode as portrait or landscape

Note : Depends on each model spec it will be supported or not

- **Get**

Header	Command	ID	Data Length	Sub CMD	Check Sum
0xAA	0xC8		0x01	0x82	

- **Set**

Header	Command	ID	Data Length	Sub Cmd	Data 1	Check Sum
0xAA	0xC8		0x02	0x82	Orientation Mode	

Orientation Mode : Same as defined info on 0xc8 sub command 0x81

- **Ack**

Header	Command	ID	Data Length	Ack/Nak	r-CMD	r-SUBCMD	Val 1
0xAA	0xFF		4	'A'	0xC8	0x82	Orientation Mode
Check Sum							

Orientation Mode : Same as defined info on 0xc8 sub command 0x81

- **Nak**

Header	Command	ID	Data Length	Ack/Nak	r-CMD	r-SUBCMD	Val 1
0xAA	0xFF		4	'N'	0xC8	0x82	ERR
Check Sum							

ERR: The error code indicating which error occurred.

2.1.C8.83 Aspect Ratio

- **Function**

Control the device aspect ratio under portrait mode which set the rotated screen to be full or original

Note : Depends on each model spec it will be supported or not

- **Get**

Header	Command	ID	Data Length	Sub CMD	Check Sum
0xAA	0xC8		0x01	0x83	

- **Set**

Header	Command	ID	Data Length	Sub Cmd	Data 1	Check Sum
0xAA	0xC8		0x02	0x83	Aspect Ratio	

Aspect Ratio

0x00	Full Screen	0x01	Original
------	-------------	------	----------

- **Ack**

Header	Command	ID	Data Length	Ack/Nak	r-CMD	r-SUBCMD	Val 1
0xAA	0xFF		4	'A'	0xC8	0x83	Aspect Ratio
Check Sum							

Aspect Ratio : Same as above

- **Nak**

Header	Command	ID	Data Length	Ack/Nak	r-CMD	r-SUBCMD	Val 1
0xAA	0xFF		4	'N'	0xC8	0x83	ERR
Check Sum							

ERR: The error code indicating which error occurred.

2.1.C8.84 PIP Rotation

- **Function**

Control the device PIP orientation which set the PIP display mode as portrait or landscape

Note : Depends on each model spec it will be supported or not

- **Get**

Header	Command	ID	Data Length	Sub CMD	Check Sum
0xAA	0xC8		0x01	0x84	

- **Set**

Header	Command	ID	Data Length	Sub Cmd	Data 1	Check Sum
0xAA	0xC8		0x02	0x84	Orientation Mode	

Orientation Mode : Same as defined info on 0xc8 sub command 0x81

- **Ack**

Header	Command	ID	Data Length	Ack/Nak	r-CMD	r-SUBCMD	Val 1
0xAA	0xFF		4	'A'	0xC8	0x84	Orientation Mode
Check Sum							

Orientation Mode : Same as defined info on 0xc8 sub command 0x81

- **Nak**

Header	Command	ID	Data Length	Ack/Nak	r-CMD	r-SUBCMD	Val 1
0xAA	0xFF		4	'N'	0xC8	0x84	ERR
Check Sum							

ERR: The error code indicating which error occurred.

2.1.C8.85 Menu Size

- **Function**

Control the device menu size

Note : Depends on each model spec it will be supported or not

- **Get**

Header	Command	ID	Data Length	Sub CMD	Check Sum
0xAA	0xC8		0x01	0x85	

- **Set**

Header	Command	ID	Data Length	Sub Cmd	Data 1	Check Sum
0xAA	0xC8		0x02	0x85	Menu Size	

Menu Size

0x00	Original	0x01	Medium
0x02	Small		

- **Ack**

Header	Command	ID	Data Length	Ack/Nak	r-CMD	r-SUBCMD	Val 1
0xAA	0xFF		4	'A'	0xC8	0x83	Menu Size
Check Sum							

Menu Size : Same as above

- **Nak**

Header	Command	ID	Data Length	Ack/Nak	r-CMD	r-SUBCMD	Val 1
0xAA	0xFF		4	'N'	0xC8	0x83	ERR
Check Sum							

ERR: The error code indicating which error occurred.

2.1.C9 Sound Menu Control

- **Function**

Control Sound Menu feature

- **Working Condition**

– Depends on each model spec it will be supported or not

- **Sub Command Table**

Sub CMD	Function	Sub CMD	Function
0x81	HDMI Sound	0x82	Equalizer 200 Hz
0x83	Equalizer 500 hz	0x84	Equalizer 2kHz
0x85	Equalizer 5kHz		

2.1.C9.81 HDMI Sound

- **Function**

Control the device hdmi sound which set the sound source as HDMI or audio in

Note :

- Depends on each model spec it will be supported or not
- This command will work only with the source of HDMI signal handling
Ex. HDMI, DVI, Magicinfo(SBB), DP

- **Get**

Header	Command	ID	Data Length	Sub CMD	Check Sum
0xAA	0xC9		0x01	0x81	

- **Set**

Header	Command	ID	Data Length	Sub Cmd	Data1	Check Sum
0xAA	0xC9		0x02	0x81	HDMI Sound	

HDMI Sound

0x00	HDMI Signal Sound	0x01	Audio In Sound
------	-------------------	------	----------------

- **Ack**

Header	Command	ID	Data Length	Ack/Nak	r-CMD	r-SUBCMD	Val 1
0xAA	0xFF		4	'A'	0xC9	0x81	HDMI Sound
Check Sum							

HDMI Sound : Same as above

- **Nak**

Header	Command	ID	Data Length	Ack/Nak	r-CMD	r-SUBCMD	Val 1
0xAA	0xFF		4	'N'	0xC9	0x81	ERR
Check Sum							

ERR: The error code indicating which error occurred.

2.1.C9.82 EQ 200Hz Control

- **Function**

Control the device sound 200Hz range equalizer to customize the volume and pitch and enhance the richness of the sound output

Note : Depends on each model spec it will be supported or not

- **Get**

Header	Command	ID	Data Length	Sub CMD	Check Sum
0xAA	0xC9		0x01	0x82	

- **Set**

Header	Command	ID	Data Length	Sub Cmd	Data 1	Check Sum
0xAA	0xC9		0x02	0x82	200Hz	

200Hz : 200Hz feild data among Equalizer set up in TV/Monitor

Note : If menu is consist as -10 ~ 0 ~ 10 level, then -10 level of menu data will be 0, 0 level data will be 0x0a and 10 level data will be 0x14

- **Ack**

Header	Command	ID	Data Length	Ack/Nak	r-CMD	r-SUBCMD	Val 1
0xAA	0xFF		4	'A'	0xC9	0x82	200Hz
Check Sum							

200Hz : Same as above

- **Nak**

Header	Command	ID	Data Length	Ack/Nak	r-CMD	r-SUBCMD	Val 1
0xAA	0xFF		4	'N'	0xC9	0x81	ERR
Check Sum							

ERR: The error code indicating which error occurred.

2.1.C9.83 EQ 500Hz Control

- **Function**

Control the device sound 500Hz range equalizer to customize the volume and pitch and enhance the richness of the sound output

Note : Depends on each model spec it will be supported or not

- **Get**

Header	Command	ID	Data Length	Sub CMD	Check Sum
0xAA	0xC9		0x01	0x83	

- **Set**

Header	Command	ID	Data Length	Sub Cmd	Data 1	Check Sum
0xAA	0xC9		0x02	0x83	500Hz	

500Hz : 500Hz feild data among Equalizer set up in TV/Monitor

Note : If menu is consist as -10 ~ 0 ~ 10 level, then -10 level of menu data will be 0, 0 level data will be 0x0a and 10 level data will be 0x14

- **Ack**

Header	Command	ID	Data Length	Ack/Nak	r-CMD	r-SUBCMD	Val 1
0xAA	0xFF		4	'A'	0xC9	0x83	500Hz
Check Sum							

500Hz : Same as above

- **Nak**

Header	Command	ID	Data Length	Ack/Nak	r-CMD	r-SUBCMD	Val 1
0xAA	0xFF		4	'N'	0xC9	0x83	ERR
Check Sum							

ERR: The error code indicating which error occurred.

2.1.C9.84 EQ 2kHz Control

- **Function**

Control the device sound 2KHz range equalizer to customize the volume and pitch and enhance the richness of the sound output

Note : Depends on each model spec it will be supported or not

- **Get**

Header	Command	ID	Data Length	Sub CMD	Check Sum
0xAA	0xC9		0x01	0x84	

- **Set**

Header	Command	ID	Data Length	Sub Cmd	Data1	Check Sum
0xAA	0xC9		0x02	0x84	2kHz	

2kHz : feild data among Equalizer set up in TV/Monitor

Note : If menu is consist as -10 ~ 0 ~ 10 level, then -10 level of menu data will be 0, 0 level data will be 0x0a and 10 level data will be 0x14

- **Ack**

Header	Command	ID	Data Length	Ack/Nak	r-CMD	r-SUBCMD	Val 1
0xAA	0xFF		4	'A'	0xC9	0x84	2kHz
Check Sum							

2kHz : Same as above

- **Nak**

Header	Command	ID	Data Length	Ack/Nak	r-CMD	r-SUBCMD	Val 1
0xAA	0xFF		4	'N'	0xC9	0x84	ERR
Check Sum							

ERR: The error code indicating which error occurred.

2.1.C9.85 EQ 5kHz Control

- **Function**

Control the device sound 5KHz range equalizer to customize the volume and pitch and enhance the richness of the sound output

Note : Depends on each model spec it will be supported or not

- **Get**

Header	Command	ID	Data Length	Sub CMD	Check Sum
0xAA	0xC9		0x01	0x85	

- **Set**

Header	Command	ID	Data Length	Sub Cmd	Data 1	Check Sum
0xAA	0xC9		0x02	0x85	5kHz	

5kHz feild data among Equalizer set up in TV/Monitor

Note : If menu is consist as -10 ~ 0 ~ 10 level, then -10 level of menu data will be 0, 0 level data will be 0x0a and 10 level data will be 0x14

- **Ack**

Header	Command	ID	Data Length	Ack/Nak	r-CMD	r-SUBCMD	Val 1
0xAA	0xFF		4	'A'	0xC9	0x85	5kHz
Check Sum							

5kHz : Same as above

- **Nak**

Header	Command	ID	Data Length	Ack/Nak	r-CMD	r-SUBCMD	Val 1
0xAA	0xFF		4	'N'	0xC9	0x85	ERR
Check Sum							

ERR: The error code indicating which error occurred.

2.1.CA System Menu Control

- **Function**

Control the features of System Menu.

- **Working Condition**

Depends on each model spec it will be supported or not

- **Sub Command Table**

Sub CMD	Function	Sub CMD	Function
0x60	SBOX Mode	0x61	Dimming Mode
0x62	Night Time Constant Brightness	0x63	Brightness Change Period
0x64	Light Sensor Effective Range	0x65	Brightness Output Range & Default Output
0x66	Latitude / longitude Info	-	-
0x70	CEC On/Off	0x71	Muli Device Grouping
-	-	0x81	Auto Source Switch On/Off
0x82	Auto Source Switch Control	0x83	Power On Delay
0x84	Synced Power On	0x85	Synced Power Off
-	-	0x91	Power Button
0x92	Touch control Admin Lock	0x93	DICOM Mode
-	-	0xA1	No Signal Power Off
0xB0	Eco Sensor Minimal Backlight	-	-

2.1.CA.60 SBOX Mode

- **Function**

Get the SBOX device indoor/outdoor mode

- **Get**

Header	Command	ID	Data Length	Sub CMD	Check Sum
0xAA	0xCA		0x01	0x60	

- **Set**

Not Support

- **Ack**

Header	Command	ID	Data Length	Ack	r-CMD	Sub CMD	Val1
0xAA	0xFF		0x04	'A'	0xCA	0x60	Mode
Check Sum							

Mode :

0x00	Indoor	0x01	Outdoor
------	--------	------	---------

- **Nak**

Header	Command	ID	Data Length	Nak	r-CMD	r-Sub Cmd	Val1
0xAA	0xFF		0x04	'N'	0xCA	0x60	ERR
Check Sum							

ERR : Error code that shows what occurred error is

2.1.CA.61 Dimming Mode

- **Function**

Control the SBOX device dimming mode

- **Get**

Header	Command	ID	Data Length	Sub CMD	Check Sum
0xAA	0xCA		0x01	0x61	

- **Set**

Header	Command	ID	Data Length	Sub CMD	Data1	Check Sum
0xAA	0xCA		0x02	0x61	Dimming Mode	

Dimming Mode

0x00	Auto	0x01	Light Sensor
0x02	Sun Rise / Sun Set	0x03	Off

- **Ack**

Header	Command	ID	Data Length	Ack	r-CMD	Sub CMD	Val1
0xAA	0xFF		0x04	'A'	0xCA	0x61	Dimming Mode
Check Sum							

Dimming Mode : Same as above

- **Nak**

Header	Command	ID	Data Length	Nak	r-CMD	r-Sub Cmd	Val1
0xAA	0xFF		0x04	'N'	0xCA	0x61	ERR
Check Sum							

ERR : Error code that shows what occurred error is

2.1.CA.62 Night Time Constant Brightness

- **Function**

Control the SBOX device brightness value as constant one or not

- **Get**

Header	Command	ID	Data Length	Sub CMD	Check Sum
0xAA	0xCA		0x01	0x62	

- **Set**

Header	Command	ID	Data Length	Sub CMD	Data1	Check Sum
0xAA	0xCA		0x02	0x62	Constant Brightness Mode	

Constant Brightness Mode

0x00	Off	0x01	On
------	-----	------	----

- **Ack**

Header	Command	ID	Data Length	Ack	r-CMD	Sub CMD	Val1
0xAA	0xFF		0x04	'A'	0xCA	0x62	Constant Brightness Mode
Check Sum							

Constant Brightness Mode : Same as above

- **Nak**

Header	Command	ID	Data Length	Nak	r-CMD	r-Sub Cmd	Val1
0xAA	0xFF		0x04	'N'	0xCA	0x62	ERR
Check Sum							

ERR : Error code that shows what occurred error is

2.1.CA.63 Brightness Change Period

- **Function**

Control the SBOX device brightness change period on day and night change

Note : It will be work only the dimming mode is set as Location mode

- **Get**

Header	Command	ID	Data Length	Sub CMD	Check Sum
0xAA	0xCA		0x01	0x63	

- **Set**

Header	Command	ID	Data Length	Sub CMD	Data1	Check Sum
0xAA	0xCA		0x02	0x63	Change Period	

Change Period : 10~70(minutes)

- **Ack**

Header	Command	ID	Data Length	Ack	r-CMD	Sub CMD	Val1
0xAA	0xFF		0x04	'A'	0xCA	0x63	Change Period
Check Sum							

Change Period : Same as above

- **Nak**

Header	Command	ID	Data Length	Nak	r-CMD	r-Sub Cmd	Val1
0xAA	0xFF		0x04	'N'	0xCA	0x63	ERR
Check Sum							

ERR : Error code that shows what occurred error is

2.1.CA.64 Light Sensor Effective Range

- **Function**

Control the SBOX device light sensor effective range

- **Get**

Header	Command	ID	Data Length	Sub CMD	Check Sum
0xAA	0xCA		0x01	0x64	

- **Set**

Header	Command	ID	Data Length	Sub CMD	Data 1	Data 2	Data 3
0xAA	0xCA		Variable	0x64	Data Type	Data	
...	Check Sum						
...							

Data Type

0x00	Minimum Effective Range	0x01	Maximum Effective Range
------	-------------------------	------	-------------------------

Note : Command can have all types of data or some of it

Data : Lux unit data of each data type

- **Ack**

Header	Command	ID	Data Length	Ack	r-CMD	Sub CMD	Val 1
0xAA	0xFF		Variable	'A'	0xCA	0x64	Data Type
Val 2	Val 3	...	Check Sum				
Data		...					

Data Type, Data : Same as above

Note : Get command ack will have all types of data

- **Nak**

Header	Command	ID	Data Length	Nak	r-CMD	r-Sub Cmd	Val 1
0xAA	0xFF		0x04	'N'	0xCA	0x64	ERR
Check Sum							

ERR : Error code that shows what occurred error is

2.1.CA.65 Brightness Output Range & Default Output

- **Function**

Control the SBOX device brightness output range and default output

- **Get**

Header	Command	ID	Data Length	Sub CMD	Check Sum
0xAA	0xCA		0x01	0x65	

- **Set**

Header	Command	ID	Data Length	Sub CMD	Data 1	Data 2	Data 3
0xAA	0xCA		Variable	0x65	Data Type	Data	
...	Check Sum						
...							

Data Type

0x00	Minimum Output Range	0x01	Maximum Output Range
0x02	Default Output		

Note : Command can have all types of data or some of it

Data : % unit data of each data type

- **Ack**

Header	Command	ID	Data Length	Ack	r-CMD	Sub CMD	Val 1
0xAA	0xFF		Variable	'A'	0xCA	0x65	Data Type
Val 2	Val 3	...	Check Sum				
Data		...					

Data Type, Data : Same as above

Note : Get command ack will have all types of data

- **Nak**

Header	Command	ID	Data Length	Nak	r-CMD	r-Sub Cmd	Val1
0xAA	0xFF		0x04	'N'	0xCA	0x65	ERR
Check Sum							

ERR : Error code that shows what occurred error is

2.1.CA.66 Latitude / longitude Info

- **Function**

Control the SBOX device latitude and longitude data

- **Get**

Header	Command	ID	Data Length	Sub CMD	Check Sum
0xAA	0xCA		0x01	0x66	

- **Set**

Header	Command	ID	Data Length	Sub CMD	Data 1	Data 2	Data 3
0xAA	0xCA		Variable	0x66	Data Type1	Data Type1 Data Length	Data Type1 Data1
...	Data M	...	Check Sum				
...	Data Type1 DataN	...					

Data Type

0x00	Latitude	0x01	Longitude
------	----------	------	-----------

Note : Command can have all types of data or some of it

Data Type Data Length : Data length of followed data

Data : String data of each data type

- **Ack**

Header	Command	ID	Data Length	Ack	r-CMD	Sub CMD	Val 1
0xAA	0xFF		Variable	'A'	0xCA	0x66	Data Type1
Val 2	...	Val M	...	Check Sum			
Data Type1 Data Length	Data Type1 Data	...					

Data Type, Data Type Data Length, Data : Same as above

Note : Get command ack will have all types of data

- **Nak**

Header	Command	ID	Data Length	Nak	r-CMD	r-Sub Cmd	Val1
0xAA	0xFF		0x04	'N'	0xCA	0x66	ERR
Check Sum							

ERR : Error code that shows what occurred error is

2.1.CA.70 CEC On/Off

- **Function**

Control the device CEC mode.

- **Get**

Header	Command	ID	Data Length	Sub CMD	Check Sum
0xAA	0xCA		0x01	0x70	

- **Set**

Header	Command	ID	Data Length	Sub CMD	Data1	Check Sum
0xAA	0xCA		0x02	0x70	CEC OnOff	

CEC On/Off

0x00	Off	0x01	On
------	-----	------	----

- **Ack**

Header	Command	ID	Data Length	Ack	r-CMD	Sub CMD	Val1
0xAA	0xFF		0x04	'A'	0xCA	0x70	CEC OnOff
Check Sum							

CEC On/Off : Same as above

- **Nak**

Header	Command	ID	Data Length	Nak	r-CMD	r-Sub Cmd	Val1
0xAA	0xFF		0x04	'N'	0xCA	0x70	ERR
Check Sum							

ERR : Error code that shows what occurred error is

2.1.CA.71 Multi Device Grouping

- **Function**

Control the device group mode control

- **Get**

Header	Command	ID	Data Length	Sub CMD	Check Sum
0xAA	0xCA		0x01	0x71	

- **Set**

Header	Command	ID	Data Length	Sub CMD	Data 1	Data 2	Check Sum
0xAA	0xCA		0x03e	0x71	Group Mode	Role	

Group Mode

0x00	Off
0x01	Group 1
0x02	Group 2
...	Up to group N

Role

0x00	Sub	0x01	Main
------	-----	------	------

- **Ack**

Header	Command	ID	Data Length	Ack	r-CMD	Sub CMD	Val 1
0xAA	0xFF		0x05	'A'	0xCA	0x71	Group Mode
Val 2	Check Sum						
Role							

Group Mode, Role : Same as above

- **Nak**

Header	Command	ID	Data Length	Nak	r-CMD	r-Sub Cmd	Val1
0xAA	0xFF		0x04	'N'	0xCA	0x71	ERR
Check Sum							

ERR : Error code that shows what occurred error is

2.1.CA.81 Auto Source Switch On/Off

- **Function**

Control the device auto source switch mode. Auto Source Switch makes automatic source change when the main source device gets disconnected

- **Get**

Header	Command	ID	Data Length	Sub CMD	Check Sum
0xAA	0xCA		0x01	0x81	

- **Set**

Header	Command	ID	Data Length	Sub CMD	Data1	Check Sum
0xAA	0xCA		0x02	0x81	Auto Source Switch	

Auto Source Switch

0x00	Off	0x01	On(Preset Input)
------	-----	------	------------------

- **Ack**

Header	Command	ID	Data Length	Ack	r-CMD	Sub CMD	Val1
0xAA	0xFF		0x04	'A'	0xCA	0x81	Auto Source Switch OnOff
Check Sum							

Auto Source Switch On/Off : Same as above

- **Nak**

Header	Command	ID	Data Length	Nak	r-CMD	r-Sub Cmd	Val1
0xAA	0xFF		0x04	'N'	0xCA	0x81	ERR
Check Sum							

ERR : Error code that shows what occurred error is

2.1.CA.82 Auto Source Switch Control

- **Function**

Control the device auto source switching related things like primary source recovery, primary source and secondary source

- **Get**

Header	Command	ID	Data Length	Sub CMD	Check Sum
0xAA	0xCA		0x01	0x82	

- **Set**

Header	Command	ID	Data Length	Sub CMD	Data 1	Data 2	Data 3
0xAA	0xCA		0x04	0x82	Primary Source Recovery	Primary Source	Secondary Source

Check Sum

Primary Source recovery

0x00	Off	0x01	On
------	-----	------	----

Primary Source : Source code to set as primary.

Code value is same with the code of 0x14 Input Source Control command

* **Note** : When try to set as "All" for primary source, it needs to set as 0x00.

Secondary Source : Source code to set as secondary.

Code value is same with the code of 0x14 Input Source Control command

- **Ack**

Header	Command	ID	Data Length	Ack	r-CMD	Sub CMD	Val1
0xAA	0xFF		0x06	'A'	0xCA	0x82	Primary Source Recovery
Val 3	Val 4	Check Sum					
Primary Source	Secondary Source						

Primary Source recovery, Primary Source, Secondary Source : Same as above

- **Nak**

Header	Command	ID	Data Length	Nak	r-CMD	r-Sub Cmd	Val1
0xAA	0xFF		0x04	'N'	0xCA	0x82	ERR
Check Sum							

ERR : Error code that shows what occurred error is

2.1.CA.83 Power On Delay

- **Function**

Control the device power on delay to prevent power overload

- **Get**

Header	Command	ID	Data Length	Sub CMD	Check Sum
0xAA	0xCA		0x01	0x83	

- **Set**

Header	Command	ID	Data Length	Sub CMD	Data 1	Check Sum
0xAA	0xCA		0x02	0x83	Power On Delay	

Power On Delay : Power on delay time of the device(second unit)

* **Note** : Pls refer device menu for range

- **Ack**

Header	Command	ID	Data Length	Ack	r-CMD	Sub CMD	Val1
0xAA	0xFF		0x04	'A'	0xCA	0x83	Power On Delay
Check Sum							

Power On Delay : Same as above

- **Nak**

Header	Command	ID	Data Length	Nak	r-CMD	r-Sub Cmd	Val1
0xAA	0xFF		0x04	'N'	0xCA	0x83	ERR
Check Sum							

ERR : Error code that shows what occurred error is

2.1.CA.84 Synced Power On

- **Function**

Control the device synced power on mode which makes turn on the connected PC module with device power on

- **Get**

Header	Command	ID	Data Length	Sub CMD	Check Sum
0xAA	0xCA		0x01	0x84	

- **Set**

Header	Command	ID	Data Length	Sub CMD	Data1	Check Sum
0xAA	0xCA		0x02	0x84	Synced Power On	

Synced Power On

0x00	Off	0x01	On
------	-----	------	----

- **Ack**

Header	Command	ID	Data Length	Ack	r-CMD	Sub CMD	Val1
0xAA	0xFF		0x04	'A'	0xCA	0x84	Synced Power On
Check Sum							

Synced Power On : Same as above

- **Nak**

Header	Command	ID	Data Length	Nak	r-CMD	r-Sub Cmd	Val1
0xAA	0xFF		0x04	'N'	0xCA	0x84	ERR
Check Sum							

ERR : Error code that shows what occurred error is

2.1.CA.85 Synced Power Off

- **Function**

Control the device synced power off mode which makes turn off the connected PC module with device power off

- **Get**

Header	Command	ID	Data Length	Sub CMD	Check Sum
0xAA	0xCA		0x01	0x85	

- **Set**

Header	Command	ID	Data Length	Sub CMD	Data1	Check Sum
0xAA	0xCA		0x02	0x85	Synced Power Off	

Synced Power Off

0x00	Off	0x01	On
------	-----	------	----

- **Ack**

Header	Command	ID	Data Length	Ack	r-CMD	Sub CMD	Val1
0xAA	0xFF		0x04	'A'	0xCA	0x85	Synced Power Off
Check Sum							

Synced Power Off : Same as above

- **Nak**

Header	Command	ID	Data Length	Nak	r-CMD	r-Sub Cmd	Val1
0xAA	0xFF		0x04	'N'	0xCA	0x85	ERR
Check Sum							

ERR : Error code that shows what occurred error is

2.1.CA.91 Power Button

- **Function**

Control the device power button mode which makes power button functionality as turn on only or toggle between on and off states

- **Get**

Header	Command	ID	Data Length	Sub CMD	Check Sum
0xAA	0xCA		0x01	0x91	

- **Set**

Header	Command	ID	Data Length	Sub CMD	Data 1	Check Sum
0xAA	0xCA		0x02	0x91	Power Button	

Power Button

0x00	Power On Only	0x01	Power On/Off
------	---------------	------	--------------

- **Ack**

Header	Command	ID	Data Length	Ack	r-CMD	Sub CMD	Val1
0xAA	0xFF		0x04	'A'	0xCA	0x91	Power Button
Check Sum							

Power Button : Same as above

- **Nak**

Header	Command	ID	Data Length	Nak	r-CMD	r-Sub Cmd	Val1
0xAA	0xFF		0x04	'N'	0xCA	0x91	ERR
Check Sum							

ERR : Error code that shows what occurred error is

2.1.CA.92 Touch control Admin Lock

- **Function**

Control the device admin menu lock mode which makes the admin menu display or not with touch event

- **Get**

Header	Command	ID	Data Length	Sub CMD	Check Sum
0xAA	0xCA		0x01	0x92	

- **Set**

Header	Command	ID	Data Length	Sub CMD	Data 1	Check Sum
0xAA	0xCA		0x02	0x92	Admin Lock	

Admin Lock

0x00	Off	0x01	On
------	-----	------	----

- **Ack**

Header	Command	ID	Data Length	Ack	r-CMD	Sub CMD	Val1
0xAA	0xFF		0x04	'A'	0xCA	0x92	Admin Lock
Check Sum							

Admin Lock : Same as above

- **Nak**

Header	Command	ID	Data Length	Nak	r-CMD	r-Sub Cmd	Val1
0xAA	0xFF		0x04	'N'	0xCA	0x92	ERR
Check Sum							

ERR : Error code that shows what occurred error is

2.1.CA.93 DICOM Mode

- **Function**

Control the DICOM mode of the device, DICOM mode set the picture setting as DICOM required

- **Get**

Header	Command	ID	Data Length	Sub CMD	Check Sum
0xAA	0xCA		0x01	0x93	

- **Set**

Header	Command	ID	Data Length	Sub CMD	Data 1	Check Sum
0xAA	0xCA		0x02	0x93	DICOM Mode	

DICOM Mode

0x00	Off	0x01	On
------	-----	------	----

- **Ack**

Header	Command	ID	Data Length	Ack	r-CMD	Sub CMD	Val1
0xAA	0xFF		0x04	'A'	0xCA	0x93	DICOM Mode
Check Sum							

DICOM Mode: Same as above

- **Nak**

Header	Command	ID	Data Length	Nak	r-CMD	r-Sub Cmd	Val1
0xAA	0xFF		0x04	'N'	0xCA	0x93	ERR
Check Sum							

ERR : Error code that shows what occurred error is

2.1.CA.A1 No Signal Power Off

- **Function**

Control the device no signal power off mode which makes turning off the device with no signal input from the current source for a certain time

- **Get**

Header	Command	ID	Data Length	Sub CMD	Check Sum
0xAA	0xCA		0x01	0xA1	

- **Set**

Header	Command	ID	Data Length	Sub CMD	Data 1	Check Sum
0xAA	0xCA		0x02	0xA1	No Signal Power Off	

No Signal Power Off

0x00	Off	0x01	15 min
0x02	30 min	0x03	60 min
0x04	10 min		

- **Ack**

Header	Command	ID	Data Length	Ack	r-CMD	Sub CMD	Val1
0xAA	0xFF		0x04	'A'	0xCA	0xA1	No Signal Power Off
Check Sum							

No Signal Power Off : Same as above

- **Nak**

Header	Command	ID	Data Length	Nak	r-CMD	r-Sub Cmd	Val1
0xAA	0xFF		0x04	'N'	0xCA	0xA1	ERR
Check Sum							

ERR : Error code that shows what occurred error is

2.1.CA.B0 Eco Sensor Minimal Backlight

- **Function**

Control the device eco sensor minimal backlight value which limit the decrease brightness auto control with eco sensor

- **Get**

Header	Command	ID	Data Length	Sub CMD	Check Sum
0xAA	0xCA		0x01	0xB0	

- **Set**

Header	Command	ID	Data Length	Sub CMD	Data 1	Check Sum
0xAA	0xCA		0x02	0xB0	Minimal Backlight	

Minimal Backlight : Minimal backlight limit value of eco sensor related control

- **Ack**

Header	Command	ID	Data Length	Ack	r-CMD	Sub CMD	Val1
0xAA	0xFF		0x04	'A'	0xCA	0xB0	Minimal Backlight
Check Sum							

Minimal Backlight: Same as above

- **Nak**

Header	Command	ID	Data Length	Nak	r-CMD	r-Sub Cmd	Val1
0xAA	0xFF		0x04	'N'	0xCA	0xB0	ERR
Check Sum							

ERR : Error code that shows what occurred error is

Eco Sensor Minimal Backlight

2.1.D0 LED Product Feature

- **Function**

- Control LED product related feature

- **Working Condition**

- Depends on each model spec it will be supported or not

- **Sub Command Table**

Sub CMD	Function	Sub CMD	Function
0x78	LED Information(Get Only)	–	–
0x81	Device Type(Get Only)	0x82	Input Source Info(Get Only)
0x83	Product Informataion(Get Only)	0x84	Monitoring(Get Only)
0x85	ABL mode	0x86	XOR Output Activation mode (Set Only)
0x87	LOD ReCheck	–	–
0x92	Module WB (RGB) Control	0x93	Cabinet CC (RGB) Control
0x94	Cabinet Backlight	0x95	Cabinet Pixel WB(RGB) CC on/off
0x96	Gamut Control	0x97	Cabinet Seam Correction
0x98	Cabinet Seam Correction on/off	0x99	Module WB(RGB) on/off
0x9A	Data Reload	0x9B	Block WB (RGB) Control
0x9C	Cabinet WB (RGB) Control	0x9D	Block WB(RGB) on/off
0x9E	Cabinet WB(RGB) on/off	0x9F	Multiple Edge Offset Control
0xA2	Block Gradation Control	0xA3	Block Gradataion On/Off
0xC2	Get diagnosis Info	0xC3	Auto ID

2.1.D0.78 LED Information

- **Function**

Get the LED module information like gamut, backlight, CC on/off, module CC on/off, seam correction on/off, dynamic peaking and SW ver

- **Get**

Header	Command	ID	Data Length	Sub CMD	Check Sum
0xAA	0xD0		0x01	0x78	

- **Set**

Not Supported

- **Ack**

Note : Reply format will be differ based on the diagnosis info type

* Overall

Header	Command	ID	Data Length	Ack	r-CMD	Sub CMD	Val1
0xAA	0xFF		Variable	'A'	0xD0	0x78	LED Info Type
Val 2	...	Val (N+1)	Check Sum				
Data Payload 1	...	Data Payload N					

LED Info Type : Replied type of diagnosis information

[Type1]

Header	Command	ID	Data Length	Ack	r-CMD	Sub CMD	Val1
0xAA	0xFF		Variable	'A'	0xD0	0x78	0x01
Val2	Val3	Val4	Val5	Val6	Val7	Val8	Val9
Cabinet Gamut	Cabinet Backlight	Cabinet CC On/Off	Module CC On/Off	Cabinet Seam Correction On/Off	Dynamic Peaking	Number Of SW Ver Data	1 st Data Type
Val10	Val11
1 st Data Length	1 st Version Data1	...	1 st Version DataN	...	N th Data Type	N th Data Length	N th Version Data1
...	...	Check Sum					
...	N th Version DataN						

Cabinet Gamut : Detail information is same with description of 0xD0 subcommand 0x96

Cabinet Backlight : Detail information is same with description of 0xD0 subcommand 0x94

Cabinet CC On/Off: Detail information is same with description of 0xD0 subcommand 0x95

Module CC On/Off: Detail information is same with description of 0xD0 subcommand 0x99

Cabinet Seam correction On/Off: Detail information is same with description of 0xD0 subcommand 0x98

Dynamic Peaking : Detail information is same with description of 0x21 subcommand 0x04

- Number Of SW Ver Data : Number of software version data info
- 1~Nth Data Type : Same as defined data on 0x1B, Sub 0xA3 Data Type
- 1~Nth Data Length : Each software version data length
- 1~Nth Version Data 1~N : String type data of each software version

- Nak

Header	Command	ID	Data Length	Ack	r-CMD	Sub CMD	Val1
0xAA	0xFF		0x04	'N'	0xD0	0x81	Err
Check Sum							

Err : Error code that shows what occurred error is.

2.1.D0.81 Device Type

- **Function**

Get the device type

- **Get**

Header	Command	ID	Data Length	Sub CMD	Check Sum
0xAA	0xD0			0x01	0x81

- **Set**

Not Supported

- **Ack**

Header	Command	ID	Data Length	Ack	r-CMD	Sub CMD	Val1
0xAA	0xFF			0x04	'A'	0xD0	0x81

Check Sum

Device Type

0x00	Reserved	0x01	SendBox
0x02	Cabinet IS / IFH / IFH-D	0x03	Cabinet IFJ(H2in1)
0x04	Cabinet IWJ	0x05	Cabinet IWR
0x06	Cabinet IER	0x07	WALL 2.0

- **Nak**

Header	Command	ID	Data Length	Ack	r-CMD	Sub CMD	Val1
0xAA	0xFF			0x04	'N'	0xD0	0x81

Check Sum

Err : Error code that shows what occurred error is.

2.1.D0.82 Input Source Info

- **Function**

Get the input source status like source list, connection status, current source and resolution

- **Get**

Header	Command	ID	Data Length	Sub CMD	Check Sum
0xAA	0xD0		0x01	0x82	

- **Set**

Not Supported

- **Ack**

Header	Command	ID	Data Length	Ack	r-CMD	Sub CMD	Val1
0xAA	0xFF		0x0a	'A'	0xD0	0x82	Source List
Val2	Val3	Val4	Val5	Val6	Val7	Check Sum	
Connection Status	Current Source	Res Width		Res Height			

Source List : Support source list(0-NotSupport, 1-Support)

Bit7	Bit6	Bit5	Bit4	Bit3	Bit2	Bit1	Bit0
Reserved	Reserved	Media Source	DP	HDMI	DVI	DSub (VGA)	HDBT

Note : Ex) 0x1f means Component, DSub, DVI HDMI and DP support

Connection Status : Connection status of support source(0-Disconnected, 1-Connected)

Bit7	Bit6	Bit5	Bit4	Bit3	Bit2	Bit1	Bit0
Reserved	Reserved	Media Source	DP	HDMI	DVI	DSub (VGA)	HDBT

Note : Ex) 0x1f means Component, DSub, DVI HDMI and DP source are connected

For the media source, it means now media player is running

Current Source : Current selected source(For detail, pls refer 0x14 command)

Res Width: Resolution width data of current selected source

Res Height: Resolution height data of current selected source

- **Nak**

Header	Command	ID	Data Length	Ack	r-CMD	Sub CMD	Val1
0xAA	0xFF		0x04	'N'	0xD0	0x82	Err
Check Sum							

Err : Error code that shows what occurred error is.

2.1.D0.83 Product Informataion

- **Function**

Get Product Information like pitch, resolution, phy size, aspect ratio and modules

- **Get**

Header	Command	ID	Data Length	Sub CMD	Check Sum
0xAA	0xD0		0x01	0x83	

- **Set**

Not Supported

- **Ack**

Header	Command	ID	Data Length	Ack	r-CMD	Sub CMD	Val1
0xAA	0xFF		0x08	'A'	0xD0	0x83	Pitch
Val2	Val3	Val4	Val5	Check Sum			
Resolution	Phy size	Aspect Ratio	Modules				

Pitch

0x01	1.15	0x02	1.5
0x03	2.0	0x04	2.5
0x05	3.0	0x06	4.0
0x07	6.0	0x08	8.0
0x09	0.84	0x0A	1.26
0x0B	1.68	0x0C	2.1
0x0D	8.5	0x0E	0.51
0x0F	0.63	-	-

Resolution

0x01	320x360 (P15 2x3)	0x02	240x270 (P20 2x3, P1.68 2x3)
0x03	192x216 (P25 2x3)	0x04	160x180 (P30 2x3)
0x05	120x135 (P40 2x3)	0x06	Reserved
0x11	192x288 (P25 2x4)	0x12	120x180 (P40 2x4)
0x13	80x120 (P60 2x4)	0x14	56x84 (P8.5 2x4)
0x21	384x216 (P25 4x3)	0x22	240x135 (P40 4x3)
0x23	160x90 (P60 4x3)	0x24	480x270 (P2.0 4x3)
0x31	960x540 (P0.84)	0x32	480x540 (P0.84 H1/2)
0x33	640x360 (P1.26, 16:9)	0x34	320x360 (P1.26 H 1/2)
0x35	480x270 (P1.68)	0x36	384x215 (P2.1)
0x41	96x216 (P25 1x3)	0x42	60x135 (P40 1x3)
0x43	40x90 (P60 1x3)	0x44	120x270 (P20 1x3)
0x45	160x360 (P1.5 1x3)	-	-
0x51	1920x1080(WALL2.0)	-	-

Phy Size

0x01	368x414 mm	0x02	480x540 mm
0x03	480x720 mm	0x04	960x540 mm
0x05	806x453 mm	0x06	403x453 mm(IFJ H1/2)
0x07	240x540mm	0x08	2422x1364 mm

Aspect Ratio

0x01	8:9	0x02	2:3
0x03	16:9	0x04	8x9(IFJ H1/2)
0x05	4:9(1x3)		

Modules

0x01	2x3	0x02	2x4
0x03	4x3	0x04	8x3
0x05	1x3	0x06	8x6

● Nak

Header	Command	ID	Data Length	Ack	r-CMD	Sub CMD	Val1
0xAA	0xFF		0x04	'N'	0xD0	0x83	Err
Check Sum							

Err : Error code that shows what occurred error is.

2.1.D0.84 Monitoring

- **Function**

Get the LED cabinet status like power&IC, HDBT status, temperature, illuminance and module LED error

- **Get**

Header	Command	ID	Data Length	Sub CMD	Check Sum
0xAA	0xD0		0x01	0x84	

- **Set**

Not Supported

- **Ack**

Header	Command	ID	Data Length	Ack	r-CMD	Sub CMD	Val1
0xAA	0xFF		Variable	'A'	0xD0	0x84	Power&IC
Val2	Val3	Val4	Val5	Val6	...	Val5	Val6
HDBT Status	Temperature	Illuminance	Module1	Module1 LED Error Data	...	ModuleN	ModuleN LED Error Data
Check Sum							

Power&IC

Bit7	Bit6	Bit5	Bit4	Bit3	Bit2	Bit1	Bit0
FPGA	STM32	Power Detect IC	4.2V	5.0V	3.3V	1.8V	1.2V

HDBT Status

Bit7	Bit6	Bit5	Bit4	Bit3	Bit2	Bit1	Bit0
Reserved	Tx IC Status	Output Signal Status	Output Connected	Reserved	Rx IC Status	Input Signal Status	Input Connected

Input Signal Status /Output Signal Status : 0-No Signal, 1-Signal is input

Input Connected /Output Connected : 0-Disconnected, 1-Connected

Tx IC Status / Rx IC Status : Error - 0, Normal - 1

Temperature : 0~254 (°C)

Illuminance : 0~100

Note : If the illuminance sensor is not exist, it will return 0xff

Module1~ N

Function	Description	Function	Description
0x1E	Module 1	0x2E	Module 2
0x3E	Module 3	0x4E	Module 4
0x5E	Module 5	0x6E	Module 6
0x7E	Module 7	0x8E	Module 8
0x9E	Module 9	0xAE	Module 10

0xBE	Module 11	0xCE	Module 12
------	-----------	------	-----------

Module1 LED Error Data N : The LED error number of each module

Note : All the Functions and Function Data are optional

- **Nak**

Header	Command	ID	Data Length	Ack	r-CMD	Sub CMD	Val1
0xAA	0xFF		0x04	'N'	0xD0	0x84	Err
Check Sum							

Err : Error code that shows what occurred error is.

2.1.D0.85 ABL mode

- **Function**

Control the device ABL mode

- **Get**

Header	Command	ID	Data Length	Sub CMD	Check Sum
0xAA	0xD0		0x01	0x85	

- **Set**

Header	Command	ID	Data Length	Sub CMD	Data1	Check Sum
0xAA	0xD0		0x02	0x85	ABL Mode	

ABL Mode : On(0x01) / Off(0x00)

- **Ack**

Header	Command	ID	Data Length	Ack	r-CMD	Sub CMD	Val1
0xAA	0xFF		0x04	'A'	0xD0	0x85	ABL Mode
Check Sum							

ABL Mode : Same as above

- **Nak**

Header	Command	ID	Data Length	Ack	r-CMD	Sub CMD	Val1
0xAA	0xFF		0x04	'N'	0xD0	0x85	Err
Check Sum							

Err : Error code that shows what occurred error is.

2.1.D0.86 Scanning Rate Mode

- **Function**

Control the device LED scanning rate mode

- **Get**

Header	Command	ID	Data Length	Sub CMD	Check Sum
0xAA	0xD0		0x01	0x86	

- **Set**

Header	Command	ID	Data Length	Sub CMD	Data1	Check Sum
0xAA	0xD0		0x02	0x86	Scanning Rate Mode	

Scanning Rate Mode : On (0x01) / Off (0x00)

- **Ack**

Header	Command	ID	Data Length	Ack	r-CMD	Sub CMD	Val1
0xAA	0xFF		0x04	'A'	0xD0	0x86	Scanning Rate Mode
Check Sum							

Scanning Rate Mode : Same as above

- **Nak**

Header	Command	ID	Data Length	Ack	r-CMD	Sub CMD	Val1
0xAA	0xFF		0x04	'N'	0xD0	0x86	Err
Check Sum							

Err : Error code that shows what occurred error is.

2.1.D0.87 LOD Recheck

- **Function**

Set the device LED LOD recheck

- **Get**

Not Supported

- **Set**

Header	Command	ID	Data Length	Sub CMD	Data1	Check Sum
0xAA	0xD0		0x02	0x87	0x00	

- **Ack**

Header	Command	ID	Data Length	Ack	r-CMD	Sub CMD	Val1
0xAA	0xFF		0x04	'A'	0xD0	0x87	0x00
Check Sum							

- **Nak**

Header	Command	ID	Data Length	Ack	r-CMD	Sub CMD	Val1
0xAA	0xFF		0x04	'N'	0xD0	0x87	Err
Check Sum							

Err : Error code that shows what occurred error is.

2.1.D0.92 Module WB (RGB) Control

- **Function**
Control the LED module white balance

- **Get**
[Type1]

Header	Command	ID	Data Length	Sub CMD	Data1	Check Sum
0xAA	0xD0		0x02	0x92	Module Info	

Module Info

Bit7	Bit6	Bit5	Bit4	Bit3	Bit2	Bit1	Bit0
Reset	Module ID			X		Y	

Reset : Reset when data is 1

Module ID : Module id of each cabinet

X : Red = 0, Green = 1, Blue = 2, All Y Line = 3

Y : Red = 0, Green = 1, Blue = 2, All X Line = 3

Note : Ex) If (X,Y) = 3,2 , Set/Get RB, GB, BB

 If (X,Y) = 1,3 , Set/Get GR, GG, GB

If Reset (bit7) is 1 and X/Y is 0x0F, current Module will be set as default on cabinet.

Ex) 0x9F means module ID1 will be set as default value.

(In case of type2 , Data1 is 0x81, Data2 is 0xff)

If Module Info is 0xFF, All Modules will be set as default on cabinet

(In case of type2 , Data1 is 0xff, Data2 is 0xff)

- [Type2]

Header	Command	ID	Data Length	Sub CMD	Data1	Data2	Check Sum
0xAA	0xD0		0x03	0x92	Module ID	Module Position	

Module ID

Bit7	Bit6	Bit5	Bit4	Bit3	Bit2	Bit1	Bit0
Reset	Module ID						

Reset, Module ID : Same as above

Module Position

Bit7	Bit6	Bit5	Bit4	Bit3	Bit2	Bit1	Bit0
X				Y			

X, Y: Same as above

- **Set**
* WB control Mode

- [Type1]

Header	Command	ID	Data Length	Sub CMD	Data1	Data2	Data3
0xAA	0xD0		Vairable	0x92	Module Info	Module Gain1 High	Module Gain1 Low
...	Data (N-1)	Data N	Check Sum				
...	Module Gain3 High	Module Gain3 Low					

Note : Each command can handle 1~3 Gain data at a one time

Module Info

Bit7	Bit6	Bit5	Bit4	Bit3	Bit2	Bit1	Bit0
Reset	Module ID			X		Y	

Module ID : Same as above

X : Same as above

Y : Same as above

Module Gain High and Low

Bit1 5	Bit1 4	Bit13	Bit12	Bit11	Bit10	Bit9	Bit8	Bit7	Bit6	Bit5	Bit4	Bit3	Bit2	Bit1	Bit0
Reserved		Module Gain Data													

Note : Reserved bits can be 0 or 1 any value

Module Gain Data : Gain data

[Type2]

Header	Command	ID	Data Length	Sub CMD	Data1	Data2	Data3
0xAA	0xD0		Vairable	0x92	Module ID	Module Postion	Module Gain1 High
Data4	...	Data (N-1)	Data N	Check Sum			
Module Gain1 Low	...	Module Gain3 High	Module Gain3 Low				

Module ID, Module Postion, Module Gain High and Low : Same as above

*** Reset all Mode**

[Type1]

Header	Command	ID	Data Length	Sub CMD	Data1	Check Sum
0xAA	0xD0		0x02	0x92	0xff	

[Type2]

Header	Command	ID	Data Length	Sub CMD	Data1	Data2	Check Sum
0xAA	0xD0		0x03	0x92	0xff	0xff	

● Ack

*** Get / Set WB control Mode**

[Type1]

Header	Command	ID	Data Length	Ack	r-CMD	Sub CMD	Val1
0xAA	0xFF		Vairable	'A'	0xD0	0x92	Module Info
Val 2	Val 3	...	Val (N-1)	Val N	Check Sum		
Module Gain1 High	Module Gain1 Low	...	Module GainN High	Module GainN Low			

Module Info, Module Gain High and Low : Same as above

[Type2]

Header	Command	ID	Data Length	Ack	r-CMD	Sub CMD	Val1
0xAA	0xFF		Vairable	'A'	0xD0	0x92	Module ID
Val 2	Val 3	Val 4	...	Val (N-1)	Val N	Check	

Module Position	Module Gain1 High	Module Gain1 Low	...	Module GainN High	Module GainN Low	Sum
-----------------	-------------------	------------------	-----	-------------------	------------------	-----

Module ID, Module Position : Same as above

Note : The gain data can be vary based on set command or get command format.

*** Reset all Mode**

[Type1]

Header	Command	ID	Data Length	Ack	r-CMD	Sub CMD	Val1
0xAA	0xFF			0x04	'A'	0xD0	0x92
Check Sum							

[Type2]

Header	Command	ID	Data Length	Ack	r-CMD	Sub CMD	Val1
0xAA	0xFF			0x05	'A'	0xD0	0x92
Val2	Check Sum						
0xff							

● Nak

Header	Command	ID	Data Length	Ack	r-CMD	Sub CMD	Val1
0xAA	0xFF			0x04	'N'	0xD0	0x92
Check Sum							

Err : Error code that shows what occurred error is.

2.1.D0.93 Cabinet CC (RGB) Control

- **Function**

Control the LED cabinet white balance

- **Get**

Header	Command	ID	Data Length	Sub CMD	Check Sum
0xAA	0xD0		0x01	0x93	

- **Set**

Header	Command	ID	Data Length	Sub CMD	Data 1	Data 2	...
0xAA	0xD0		Vairable	0x93	Cabinet Gain1 High	Cabinet Gain1 Low	...
Data (N-1)	Data N	Check Sum					
Cabinet Gain3 High	Cabinet Gain3 Low						

Note : Each command can handle 1~3 Gain data at a one time

Cabinet Gain High and Low

Bit1 5	Bit1 4	Bit13	Bit12	Bit11	Bit10	Bit9	Bit8	Bit7	Bit6	Bit5	Bit4	Bit3	Bit2	Bit1	Bit0
Reserved				R	G	B	Cabinet Gain Data								

Note : Reserved can be 0 or 1 any value

R/G/B : R/G/B

Cabinet Gain Data : Cabinet gain data

- **Ack**

Header	Command	ID	Data Length	Ack	r-CMD	Sub CMD	Val1
0xAA	0xFF		Vairable	'A'	0xD0	0x93	Cabinet Gain1 High
Val 2	...	Val (N-1)	Val N	Check Sum			
Cabinet Gain1 Low	...	Cabinet GainN High	Cabinet GainN Low				

Cabinet Gain High and Low

Bit1 5	Bit1 4	Bit13	Bit12	Bit11	Bit10	Bit9	Bit8	Bit7	Bit6	Bit5	Bit4	Bit3	Bit2	Bit1	Bit0
Reserved		Cabinet Gain Data													

Note : Reserved bits can be 0 or 1 any value

Cabinet Gain Data : Gain data

- **Nak**

Header	Command	ID	Data Length	Ack	r-CMD	Sub CMD	Val1
0xAA	0xFF		0x04	'N'	0xD0	0x93	Err
Check							

Sum

Err : Error code that shows what occurred error is.

2.1.D0.94 Cabinet Backlight

- **Function**

Control the cabinet backlight

- **Get**

Header	Command	ID	Data Length	Sub CMD	Check Sum
0xAA	0xD0		0x01	0x94	

- **Set**

Header	Command	ID	Data Length	Sub CMD	Data 1	Check Sum
0xAA	0xD0		0x02	0x94	Cabinet Backlight	

Cabinet Backlight : Backlight data, 0x00 ~ 0x0A(0 ~ 10)

- **Ack**

Header	Command	ID	Data Length	Ack	r-CMD	Sub CMD	Val1
0xAA	0xFF		0x04	'A'	0xD0	0x94	Cabinet Backlight
Check Sum							

Cabinet Backlight : Same as Above

- **Nak**

Header	Command	ID	Data Length	Ack	r-CMD	Sub CMD	Val1
0xAA	0xFF		0x04	'N'	0xD0	0x94	Err
Check Sum							

Err : Error code that shows what occurred error is.

2.1.D0.95 Cabinet Pixel WB(RGB) CC on/off

- **Function**

Control the cabinet CC

- **Get**

Header	Command	ID	Data Length	Sub CMD	Check Sum
0xAA	0xD0		0x01	0x95	

- **Set**

Header	Command	ID	Data Length	Sub CMD	Data 1	Check Sum
0xAA	0xD0		0x02	0x95	Pixel RGB CC On/Off	

Pixel RGB CC On/off Data Value : Off (0x00) , On(0x01)

- **Ack**

Header	Command	ID	Data Length	Ack	r-CMD	Sub CMD	Val1
0xAA	0xFF		0x04	'A'	0xD0	0x95	Pixel RGB CC on/off
Check Sum							

Pixel RGB CC on/off : Same as Above

- **Nak**

Header	Command	ID	Data Length	Ack	r-CMD	Sub CMD	Val1
0xAA	0xFF		0x04	'N'	0xD0	0x95	Err
Check Sum							

Err : Error code that shows what occurred error is.

2.1.D0.96 Gamut Control

- **Function**

Control the cabinet gamut

- **Get**

Header	Command	ID	Data Length	Sub CMD	Check Sum
0xAA	0xD0		0x01	0x96	

- **Set**

Header	Command	ID	Data Length	Sub CMD	Data 1	Check Sum
0xAA	0xD0		0x02	0x96	Cabinet Gamut	

Cabinet Gamut

0x00	Natural(Or Custom) (off)	0x01	S-RGB(or BT.709)
0x02	Adobe RGB	0x03	DCI-P3

Note : Depends on the product spec gamut will works as differently

Ex) Gamut 0x01 will work as S-RGB or BT.709

- **Ack**

Header	Command	ID	Data Length	Ack	r-CMD	Sub CMD	Val1
0xAA	0xFF		0x04	'A'	0xD0	0x96	Cabinet Gamut
Check Sum							

Cabinet Gamut : Same as above

- **Nak**

Header	Command	ID	Data Length	Ack	r-CMD	Sub CMD	Val1
0xAA	0xFF		0x04	'N'	0xD0	0x96	Err
Check Sum							

Err : Error code that shows what occurred error is.

2.1.D0.97 Cabinet Seam Correction

- **Function**

Control the LED module seam correction

Note : Each command can handle 1 or 4 Edge Correction data at a one time

- **Get**

[Type1]

Header	Command	ID	Data Length	Sub CMD	Data1	Check Sum
0xAA	0xD0		0x02	0x97	Module Info	

Module Info

Bit7	Bit6	Bit5	Bit4	Bit3	Bit2	Bit1	Bit0
Reset	Module ID			Edge info			

Reset : 1-Reset, 0-Do Nothing

Module ID : Module ID of each cabinet

Edge Info

0x00	Up side edge	0x01	Left side edge
0x02	Bottom side edge	0x03	Right side edge
0x04	All edge	-	-

[Type2]

Header	Command	ID	Data Length	Sub CMD	Data1	Data2	Check Sum
0xAA	0xD0		0x03	0x97	Module ID	Module Edgeinfo	

Module ID

Bit7	Bit6	Bit5	Bit4	Bit3	Bit2	Bit1	Bit0
Reset	Module ID						

Reset : Same as above

Module ID : Same as above

Module Edgeinfo

Bit7	Bit6	Bit5	Bit4	Bit3	Bit2	Bit1	Bit0
Edge info							

Edge Info : Same as above

- **Set**

* Seam Correction Mode

[Type1]

Header	Command	ID	Data Length	Sub CMD	Data1	Data2	Data3
0xAA	0xD0		Vairable	0x97	Module Info	Edge Corr Data 1 High Byte	Edge Corr Data 1 Low Byte
...	Data (N-1)	Data N	Check Sum				
...	Edge Corr Data	Edge Corr Data					

	4 High Byte	4 Low Byte	
--	-------------	------------	--

Module Info : Same as above

Edge Seam Correction data High and Low : Edge seam correction data

[Type2]

Header	Command	ID	Data Length	Sub CMD	Data1	Data2	Data3
0xAA	0xD0		Vairable	0x97	Module ID	Module Edgeinfo	Edge Seam Correction Data1 High Byte
Data4	...	Data (N-1)	Data N	Check Sum			
Edge Seam Correction Data1 Low Byte	...	Edge Seam Correction Data4 High Byte	Edge Seam Correction Data4 Low Byte				

Module ID, Module Edgeinfo : Same as above

Edge Seam Correction data High and Low : Edge seam correction data

*** Reset All Modules**

Header	Command	ID	Data Length	Sub CMD	Data 1	Check Sum
0xAA	0xD0		0x02	0x97	0xff	

Note : If Reset (bit7) is 1 and Edge Info is 0x0F, All Edges of currnet Module will be set as default.

Ex) 0x9F means module ID1 will be set as default value.

If Module Edge Info is 0xFF, All Modules will be set as default value

● Ack

*** Get / Set Seam Correction Mode**

[Type1]

Header	Command	ID	Data Length	Ack	r-CMD	Sub CMD	Val1
0xAA	0xFF		Vairable	'A'	0xD0	0x97	Module Info
Val2	Val3	...	Val (N-1)	Val N	Check Sum		
Edge Seam Correction Data1 High Byte	Edge Seam Correction Data1 Low Byte	...	Edge Seam Correction Data4 High Byte	Edge Seam Correction Data4 Low Byte			

Module Info, Edge Seam Correction data High and Low : Same as above

[Type2]

Header	Command	ID	Data Length	Ack	r-CMD	Sub CMD	Val1
0xAA	0xFF		Vairable	'A'	0xD0	0x97	Module ID
Val2	Val3	Val4	...	Val (N-1)	Val N	Check Sum	
Module Edgeinfo	Edge Seam Correction Data1 High Byte	Edge Seam Correction Data1 Low Byte	...	Edge Seam Correction Data4 High Byte	Edge Seam Correction Data4 Low Byte		

Module ID, Module Edgeinfo, Edge Seam Correction data High and Low : Same as above

*** Reset All Mode**

Header	Command	ID	Data Length	Ack	r-CMD	Sub CMD	Val1
0xAA	0xFF		0x04	'A'	0xD0	0x97	0xff
Check Sum							

• Nak

Header	Command	ID	Data Length	Ack	r-CMD	Sub CMD	Val1
0xAA	0xFF		0x04	'N'	0xD0	0x97	Err
Check Sum							

Err : Error code that shows what occurred error is.

2.1.D0.98 Cabinet Seam Correction on/off

- **Function**

Control the LED cabinet seam(edge) correction mode

- **Get**

Header	Command	ID	Data Length	Sub CMD	Check Sum
0xAA	0xD0		0x01	0x98	

- **Set**

Header	Command	ID	Data Length	Sub CMD	Data 1	Check Sum
0xAA	0xD0		0x02	0x98	Seam(Edge) Correction On/Off	

Seam(Edge) Correcton On/off Data Value : Off (0x00), On(0x01)

- **Ack**

Header	Command	ID	Data Length	Ack	r-CMD	Sub CMD	Val1
0xAA	0xFF		0x04	'A'	0xD0	0x98	Seam(Edge) Correction On/Off

Check Sum

Seam(Edge) Correction on/off : Same as above

- **Nak**

Header	Command	ID	Data Length	Ack	r-CMD	Sub CMD	Val1
0xAA	0xFF		0x04	'N'	0xD0	0x98	Err

Check Sum

Err : Error code that shows what occurred error is.

2.1.D0.99 Module WB(RGB) on/off

- **Function**

Control the LED moduel WB(RGB) CC mode

- **Get**

Header	Command	ID	Data Length	Sub CMD	Check Sum
0xAA	0xD0		0x01	0x99	

- **Set**

Header	Command	ID	Data Length	Sub CMD	Data 1	Check Sum
0xAA	0xD0		0x02	0x99	Module CC On/Off	

Module CC On/off : Off (0x00), On(0x01)

- **Ack**

Header	Command	ID	Data Length	Ack	r-CMD	Sub CMD	Val1
0xAA	0xFF		0x04	'A'	0xD0	0x99	Module CC on/off
Check Sum							

Module CC on/off : Same as above

- **Nak**

Header	Command	ID	Data Length	Ack	r-CMD	Sub CMD	Val1
0xAA	0xFF		0x04	'N'	0xD0	0x99	Err
Check Sum							

Err : Error code that shows what occurred error is.

2.1.D0.9A Data Reload

- **Function**

Set the LED cabinet data reload

- **Get**

Not Supported

- **Set**

Header	Command	ID	Data Length	Sub CMD	Data 1	Check Sum
0xAA	0xD0		0x02	0x9A	Data Type	

[Data Type](#)

-	-	0x01	Pixel RGB
0x02	Over Voltage Count	0x03	LOD
0x04	RM Data	-	-

- **Ack**

Header	Command	ID	Data Length	Ack	r-CMD	Sub CMD	Val1
0xAA	0xFF		0x04	'A'	0xD0	0x9A	0x01
Check Sum							

- **Nak**

Header	Command	ID	Data Length	Ack	r-CMD	Sub CMD	Val1
0xAA	0xFF		0x04	'N'	0xD0	0x9A	Err
Check Sum							

[Err](#) : Error code that shows what occurred error is.

2.1.D0.9B Block WB (RGB) Control

- **Function**

Control the LED block white balance

- **Get**

Header	Command	ID	Data Length	Sub CMD	Data1	Data2	Data3
0xAA	0xD0		Variable	0x9B	Color Mode	Module ID	Block ID
...	Data N	Check Sum					
...	Block ID N						

Module ID

Bit7	Bit6	Bit5	Bit4	Bit3	Bit2	Bit1	Bit0
Module ID							

Block ID

Bit7	Bit6	Bit5	Bit4	Bit3	Bit2	Bit1	Bit0
Reset	Block ID						

Color mode : low : 0x00 / high : 0x01 mode

Module ID : Module id of each cabinet

Reset : Reset when data is 1

Block ID : Block id of each cabinet

- **Se**

* WB control Mode

Header	Command	ID	Data Length	Sub CMD	Data1	Data2	Data3
0xAA	0xD0		Variable	0x9B	Color Mode	Module ID	BlockID1
Data4	Data5	...	Data20	Data21	Data 22	Data N	Check Sum
Block Gain1 High	Block Gain1 Low		Block Gain3 High	Block Gain3 Low	BlockID N	...	

ColorMode, Module ID, Block ID, Block Gain High and Low : Same as above

* Reset all Mode

Header	Command	ID	Data Length	Sub CMD	Data1	Data2	Data3
0xAA	0xD0		0x04	0x9B	Color Mode	Module ID	0xff
Check Sum							

- **Ack**

* Get / Set WB control Mode

Header	Command	ID	Data Length	Ack	r-CMD	Sub CMD	Val1
0xAA	0xFF		Variable	'A'	0xD0	0x9B	Color Mode
Val2	Val 3	Val 4	Val 5	...	Data20	Data21	Data22

Module ID	Block ID 1	Block Gain1 High	Block Gain1 Low	...	Block GainN High	Block GainN Low	Block ID N
Data N	Check Sum						
...							

Color Mode, Module ID, Block ID: Same as above

Note : The gain data can be vary based on set command or get command format.

* Reset all Mode

Header	Command	ID	Data Length	Ack	r-CMD	Sub CMD	Val1
0xAA	0xFF		Check Sum	0x06	'A'	0xD0	0x9B
Val2	Val3						
Module ID	0xff						

● Nak

Header	Command	ID	Data Length	Ack	r-CMD	Sub CMD	Val1
0xAA	0xFF		Check Sum	0x04	'N'	0xD0	0x9B

Err : Error code that shows what occurred error is.

2.1.D0.9C Cabinet WB (RGB) Control

- **Function**

Control the cabinet white balance(RGB)

- **Get**

Header	Command	ID	Data Length	Sub CMD	Data 1	Check Sum
0xAA	0xD0		0x02	0x9C	CabinetCC Position	

CabinetCC Position

Bit7	Bit6	Bit5	Bit4	Bit3	Bit2	Bit1	Bit0
X				Y			

X : Red = 0, Green = 1, Blue = 2, All Y Line = 3

Y : Red = 0, Green = 1, Blue = 2, All X Line = 3

Note : Ex) If (X,Y) = 3,2 , Set/Get RB, GB, BB

 If (X,Y) = 1,3 , Set/Get GR, GG, GB

If X/Y is 0x0F, current Cabinet CC value will be set as default on cabinet.

Ex) Data1 is 0xff means cabinet CC will be set as default value.

- **Set**

* WB control Mode

Header	Command	ID	Data Length	Sub CMD	Data1	Data2	Data3
0xAA	0xD0		Variable	0x9C	CabinetCC Position	Cabinet Gain1 High	Cabinet Gain1 Low
...	Data (N-1)	Data N	Check Sum				
...	CabinetCC Gain3 High	CabinetCC Gain3 Low					

CabinetCC Position, Cabinet Gain High and Low : Same as above

* Reset all Mode

Header	Command	ID	Data Length	Sub CMD	Data1	Check Sum
0xAA	0xD0		0x02	0x9C	0xff	

- **Ack**

* Get / Set WB control Mode

Header	Command	ID	Data Length	Ack	r-CMD	Sub CMD	Val1
0xAA	0xFF		Variable	'A'	0xD0	0x9C	CabinetCC Position
Val2	Val3	...	Val (N-1)	Val N	Check sum		
Cabinet Gain1 High	Cabinet Gain1 Low	...	Cabinet GainN High	Cabinet GainN Low			

CabinetCC Position : Same as above

Note : The gain data can be vary based on set command or get command format.

*** Reset all Mode**

Header	Command	ID	Data Length	Ack	r-CMD	Sub CMD	Val1
0xAA	0xFF		0x04	'A'	0xD0	0x9C	0xff
Check Sum							

• Nak

Header	Command	ID	Data Length	Ack	r-CMD	Sub CMD	Val1
0xAA	0xFF		0x04	'N'	0xD0	0x9C	Err
Check Sum							

Err : Error code that shows what occurred error is.

2.1.D0.9D Block WB(RGB) on/off

- **Function**

Control the LED block CC mode

- **Get**

Header	Command	ID	Data Length	Sub CMD	Check Sum
0xAA	0xD0		0x01	0x9D	

- **Set**

Header	Command	ID	Data Length	Sub CMD	Data 1	Check Sum
0xAA	0xD0		0x02	0x9D	Block CC On/Off	

Block CC On/off : Off (0x00), On(0x01)

- **Ack**

Header	Command	ID	Data Length	Ack	r-CMD	Sub CMD	Val1
0xAA	0xFF		0x04	'A'	0xD0	0x9D	Block CC on/off
Check Sum							

Block CC on/off : Same as above

- **Nak**

Header	Command	ID	Data Length	Ack	r-CMD	Sub CMD	Val1
0xAA	0xFF		0x04	'N'	0xD0	0x9D	Err
Check Sum							

Err : Error code that shows what occurred error is.

2.1.D0.9E Cabinet WB(RGB) on/off

- **Function**

Control the cabinet WB(RGB) CC mode

- **Get**

Header	Command	ID	Data Length	Sub CMD	Check Sum
0xAA	0xD0		0x01	0x9E	

- **Set**

Header	Command	ID	Data Length	Sub CMD	Data 1	Check Sum
0xAA	0xD0		0x02	0x9E	Cabinet CC On/Off	

Cabinet CC On/off : Off (0x00), On(0x01)

- **Ack**

Header	Command	ID	Data Length	Ack	r-CMD	Sub CMD	Val1
0xAA	0xFF		0x04	'A'	0xD0	0x9E	Cabinet CC on/off
Check Sum							

Cabinet CC on/off : Same as above

- **Nak**

Header	Command	ID	Data Length	Ack	r-CMD	Sub CMD	Val1
0xAA	0xFF		0x04	'N'	0xD0	0x9E	Err
Check Sum							

Err : Error code that shows what occurred error is.

2.1.D0.9F Multiple Edge Offset Control

- **Function**

Control the LED moduel edge correction data

- **Get**

Not Supported

- **Set**

Header	Command	ID	Data Length	Sub CMD	Data1	Data2	Data3
0xAA	0xD0		Variable	0x9F	Information	Offset High	Offset Low
Data4	Data5		Data (N-1)	Data N	Check Sum		
Module ID	Edge Info	...	Module ID	Edge Info			

Information : Preview : 0x00 / Apply : 0x01

0x00	Preview	0x01	Apply
0x02	Clear		

Note : If Information is 0x02 (Clear), there no data for offset and followed..

Offset High and Low : Edge seam correction offset data(Signed integer)

Module ID : Module id of each cabinet

Edge Info :

Bit7	Bit6	Bit5	Bit4	Bit3	Bit2	Bit1	Bit0
Reserved	Reserved	Reserved	Reserved	Bottom	Right	Left	Top

Note : If edge info is Left data would be 0x02, if it is Bottom then 0x08

- **Ack**

Header	Command	ID	Data Length	Ack	r-CMD	Sub CMD	Val1
0xAA	0xFF		Variable	'A'	0xD0	0x9F	Information
Val2	Val 3	Val 4	Val15		Val (N-1)	Val N	Check sum
Offset High	Offset Low	Module ID	Edge Info	...	Module ID	Edge Info	

Information, Offset High and Low, Module ID, Edge Info : Same as above

Note : The gain data can be vary based on set command or get command format.

Ack data will matched with set data.

For example information : clear will not carry other data so the reply also carry the information only.

- **Nak**

Header	Command	ID	Data Length	Ack	r-CMD	Sub CMD	Val1
0xAA	0xFF		0x04	'N'	0xD0	0x9F	Err
Check Sum							

Err : Error code that shows what occurred error is.

2.1.D0.A2 Block Gradation Control

- **Function**

Control the Gradation of Block of LED Module

- **Get**

Header	Command	ID	Data Length	Sub CMD	Data1	Check Sum
0xAA	0xD0		0x02	0xA2	Module ID	

Module ID : Module id of each cabinet

Note : Get will return all block data of selected module

- **Set**

- ***WB control Mode**

Header	Command	ID	Data Length	Sub CMD	Data1	Data2	Data3
0xAA	0xD0		Variable	0xA2	Module ID	Block ID 1	Block 1 Gradation Red High
Data4	Data5	Data6	Data7	Data8
Block 1 Gradation Red Low	Block 1 Gradation Green		Block 1 Gradation Blue		...	Block ID N	Block N Gradation Red High
...	Data N	Check Sum		
Block N Gradation Red Low	Block N Gradation Green		Block 1 Gradation Blue				

Module ID : Same as above

Block ID : Block id of each cabinet

Block Gradation Red/Green/Blue : Block gradation data

- *** Reset all Mode**

Header	Command	ID	Data Length	Sub CMD	Data1	Data2	CheckSum
0xAA	0xD0		0x03	0xA2	Module ID	0xff	

- **Ack**

- *** Get / Set WB control Mode**

Header	Command	ID	Data Length	Ack	r-CMD	Sub CMD	Val1
0xAA	0xFF		Variable	'A'	0xD0	0xA2	Module ID
Val2	Val3	Val4	Val5	Data6	Data7	Data8	...
Block ID 1	Block 1 Gradation Red		Block 1 Gradation Green		Block 1 Gradation Blue		...
...	Data N	Check Sum
Block ID N	Block N Gradation Red		Block N Gradation Green		Block N Gradation Blue		

Module ID, Block ID, Block Gradation Red/Green/Blue : Same as above

* **Reset all Mode**

Header	Command	ID	Data Length	Ack	r-CMD	Sub CMD	Val1
0xAA	0xFF			0x05	'A'	0xD0	0xA2
Val2	Checksum						
0xff							

Module ID: Same as above

● **Nak**

Header	Command	ID	Data Length	Ack	r-CMD	Sub CMD	Val1
0xAA	0xFF			0x04	'N'	0xD0	0xA2
Check Sum							

Err : Error code that shows what occurred error is.

2.1.D0.A3 Block Gradation on/off

- **Function**

Control Block Gradation mode of LED Module

- **Get**

Header	Command	ID	Data Length	Sub CMD	Check Sum
0xAA	0xD0		0x03	0xA3	

- **Set**

Header	Command	ID	Data Length	Sub CMD	Data1	CheckSum
0xAA	0xD0		0x02	0xA3	Block Gradation On/Off	

Block Gradation On/Off : Off (0x00), On(0x01)

- **Ack**

Header	Command	ID	Data Length	Ack	r-CMD	Sub CMD	Val1
0xAA	0xFF		0x04	'A'	0xD0	0xA3	Block Gradation On/Off
Check Sum							

Block Gradation On/Off : Same as above

- **Nak**

Header	Command	ID	Data Length	Ack	r-CMD	Sub CMD	Val1
0xAA	0xFF		0x04	'N'	0xD0	0xA3	Err
Check Sum							

Err : Error code that shows what occurred error is

2.1.D0.C2 Get Diagnosis Information

- **Function**

Get the diagnosis related information,

Note : This command is designed as combination of gathered by several other commands and for cabinet diagnosis information gathering performance improving

- **Get**

Header	Command	ID	Length	Sub CMD	Check Sum
0xAA	0xD0		0x01	0xC2	

- **Set**

Not Supported

- **Ack**

Note : Reply format will be differ based on the diagnosis info type

* Overall

Header	Command	ID	Data Length	Ack	r-CMD	Sub CMD	Val1
0xAA	0xFF		Variable	'A'	0xD0	0xC2	Diagnosis Info Type
Val2	...	Val (N+1)	Check Sum				
Data Payload 1	...	Data Payload N					

Diagnosis Info Type : Replied type of diagnosis information

* Diagnosis Information Type 1

Header	Command	ID	Data Length	Ack	r-CMD	Sub CMD	Val1
0xAA	0xFF		Variable	'A'	0xD0	0xC2	0x01
Val2	Val 3	Val 4	Val 5	Val 6	Val 7	Val 8	Val 9
Pitch	Resolution	Phy size	Aspect Ratio	Modules	ABL Mode	Auto Source Switch OnOff	OSD
Val 10	Val 11	Val 12	Val 13	Val 14	Val 15	...	Val (N-1)
Power&IC	HDBT Status	Temperature	Illuminance	Module1	Module1 LED Error Data	...	ModuleN
Val N	Check Sum						
ModuleN LED Error Data							

Diagnosis Info Type : same as above

Pitch : Detail information is same with description of 0xD0 subcommand 0x83

Resolution : Detail information is same with description of 0xD0 subcommand 0x83

Phy Size : Detail information is same with description of 0xD0 subcommand 0x83

Aspect Ratio : Detail information is same with description of 0xD0 subcommand 0x83

Modules : Detail information is same with description of 0xD0 subcommand 0x83

- ABL Mode** : Detail information is same with description of 0xD0 subcommand 0x85
- Auto Source Switch On/Off**: Detail information is same with description of 0xCA subcommand 0x81
- OSD** : Detail information is same with description of 0x70
- Power&IC** : Detail information is same with description of 0xD0 subcommand 0x84
- HDBT Status** : Detail information is same with description of 0xD0 subcommand 0x84
- Temperature** : Detail information is same with description of 0xD0 subcommand 0x84
- Illuminance** : Detail information is same with description of 0xD0 subcommand 0x84
- Module N** : Detail information is same with description of 0xD0 subcommand 0x84
- Module1 LED Error Data N** : Detail information is same with description of 0xD0 subcommand 0x84

● **Nak**

Header	Command	ID	Data Length	Ack	r-CMD	Sub CMD	Val1
0xAA	0xFF		0x04	'N'	0xD0	0xC1	Err
Check Sum							

Err : Error code that shows what occurred error is.

2.1.D0.C3 Auto ID

- **Function**

Control the LED cabinet auto ID functionality and get it's status

- **Get**

Header	Command	ID	Length	Sub CMD	Check Sum
0xAA	0xD0		0x01	0xC3	

- **Set**

Header	Command	ID	Length	Sub CMD	Data 1	Check Sum
0xAA	0xD0		0x02	0xC3	0x01	

- **Ack**

* Ack of Get

Header	Command	ID	Data Length	Ack	r-CMD	Sub CMD	Val1
0xAA	0xFF		0x05	'A'	0xD0	0xC3	Auto ID Status
Val2	Check Sum						
Last Device ID							

Auto ID Status

0x00	In Progress	0x01	Done
------	-------------	------	------

Last Device ID : Assigned ID number by auto ID function to last detected device

Note : First device ID is fixed as 2

If Auto ID Status is returns as "In Progress" then Last Device ID data is invalid

* Ack of Set

Header	Command	ID	Data Length	Ack	r-CMD	Sub CMD	Val1
0xAA	0xFF		0x04	'A'	0xD0	0xC3	0x01
Check Sum							

- **Nak**

Header	Command	ID	Data Length	Ack	r-CMD	Sub CMD	Val1
0xAA	0xFF		0x04	'N'	0xD0	0xC3	Err
Check Sum							

Err : Error code that shows what occurred error is.

2.1.D2 Large Sized Data Control

- **Function**

Control large sized data.

Note : On this command reply also be a more than 256byte data(difference with 0xd1 command)

- **Working Condition**

– Depends on each model spec it will be supported or not

- **Sub Command Table**

Sub CMD	Function	Sub CMD	Function
0x20	File Download & Install	-	-

Note : Grey colored commands are described in common section

2.1.D2.20 File Download & Install

- **Function**

Download the file data and install to device

- **Get**

Not Supported

- **Set**

Header	Command	ID	Data Length – High	Data Length – Low	Sub CMD	Data 1	Data 2
0xAA	0xD2		Vairable		0x20	Download Mode	File Type High Byte
Data 3	Data 4	Data 5	...	Data M	Data M+1	...	Data N
File Type Low Byte	File Name Length	File Name Data		File Data Length		File Data	
Check Sum							

Download Mode

0x00	Download Only	-	-
------	---------------	---	---

File Type

File Type	DESCRIPTION
0x0000	802.1x Authentication – Root
0x0001	802.1x Authentication – Client

File Name Length : File name length which will be transferred

File Name Data : File name which will be transferred

File Data Length : File data length which will be transferred

File Data : File data which will be transferred

- **Ack**

Header	Command	ID	Data Length – High	Data Length – Low	Ack	r-CMD	r-Sub CMD
0xAA	0xFF		Vairable		'A'	0xD2	0x20
Check Sum							

Note : This command ack dose not contain a received data

- **Nak**

Header	Command	ID	Data Length – High	Data Length – Low	Ack	r-CMD	r-Sub CMD
0xAA	0xFF		0x0004		'N'	0xD2	0x42
Val1	Check						

Err	Sum
-----	-----

Err : Error code that shows what occurred error is.

2.1.E0 Net PIP (MagicInfo Only)

● Function

Control the device PIP related things like horizontal/vertical start position, horizontal/vertical size, source, channel, sound select, country, ATV/DTV, air/cable, ch num and minor ch num

Note : 1. The possible PIP composition and PIP size depends on H/W spec.

2. After Net PIP turns on, if user changes other sources and come back to Magicinfo, Net PIP also should be shown.

● Get

Not Support

● Set

[PIP On]

Header	Command	ID		Data Length	PIP ON	Data 1	Data 2	Data 3
0xAA	0xE0			0x14	0x01	H Position		V Position High-Byte
Data 4	Data 5	Data 6	Data 7	Data 8	Data 9	Data 10	Data 11	
V Position Low-Byte	H Size		V Size		P.Source	TV Channel	S.Select	
Data 12	Data 13	Data 14	Data 15	Data 16	Data 17	Data 18	Data 19	
Country	ATV/DTV	AirCable	CH_NUM		Sel_Minor	Minor_CH		
Check Sum								

H Position : The Position value code for PIP H-Start

V Position : The Position value code for PIP V-Start

H Size : The Size value code for PIP H-width

V Size : The Size value code for PIP V-width

Note : The PIP Start Position and Size do not over panel H, V size

P.Source : The input source code to set for the TV or monitor.

- Please refer Input table of Command 0x14, Input Source Control (MFM).

TV Channel : Channel Number (0 ~ 99)

Note : 460Txn Only (Platform LFD don't use this byte)

S.Select : The Sound select Code

0x00	MagicInfo Sound	0x01	PIP Sound
------	-----------------	------	-----------

Country : The value code for the country of the Device(0 : Korea, 1 : U.S.A, ...)

ATV_DTV : The value code for the ATV/DTV of the Device(0 : Analog TV, 1 : Digital TV)

AirCable : The value code for the Air/Cable of the Device(0 : Air, 1 : Cable)

CH_NUM High_Byte : The value code for the Major Channel High-Byte of the TV / DTV
(Analog TV : 1 ~ 135, Digital TV : 0 ~ 999)

CH_NUM Low_Byte : The value code for the Major Channel Low-Byte of the TV / DTV
(Analog TV : 1 ~ 135, Digital TV : 0 ~ 999)

Sel_Minor : The value code for the Minor Channel Enable/Disable of the Device
(0 : Enable, 1 : Disable)(DTV Only)

Minor_CH High_Byte : The value code for the Minor Channel High-Byte of the TV / Monitor(0 ~ 999)(DTV Only)

Minor_CH Low_Byte : The value code for the Minor Channel Low-Byte of the TV / Monitor(0 ~ 999)(DTV Only)

Note : CH_NUM High_Byte = 0xFF, CH_NUM Low_Byte = 0xFF, Sel_Minor =

0x01, Minor_CH High_Byte = 0xFF, Minor_CH Low_Byte = 0xFF
 => Net PIP tune as last Memory channel of TV source

[PIP Off]

Header	Command	ID	Data Length	PIP Off	Check Sum
0xAA	0xE0		0x01	0x00	

● **Ack**

Header	Command	ID	Data Length	Ack/Nak	r-CMD	PIP ON	Val 1
0xAA	0xFF		0x16	'A'	0xE0	0x01	H Position High -Byte
Val 2	Val 3	Val 4	Val 5	Val 6	Val 7	Val 8	Val 9
H Position Low -Byte	V Position		H Size		V Size		P.Source
Val 10	Val 11	Val 12	Val 13	Val 14	Val 15	Val 16	Val 17
TV Channel	S.Select	Country	ATV_DTV	AirCable	CH_NUM		Sel_Minor
Val 18	Val 19	Check Sum					
Minor_CH							

Val 1 ~ Val 19 : Same as above

● **Nak**

Header	Command	ID	Data Length	Ack/Nak	r-CMD	Val 1	Check Sum
0xAA	0xFF		3	'N'	0xE0	ERR	

ERR : Error Code which is displayed when error is occurred.

2.1.E4 Apply To Status Control On Video Wall

- **Function**

Control source contents which is shown on video wall

- **Get**

Header	Command	ID	Data Length	Check Sum
0xAA	0xE4		0x00	

- **Set**

Header	Command	ID	Data Length	Data 1	Check Sum
0xAA	0xE4		0x01	Status	

Status : value of Apply to settings status.

0x00	Current Source	0x01	MagiInfo Player S
------	----------------	------	-------------------

- **Ack**

Header	Command	ID	Data Length	Ack/Nak	r-CMD	Val 1	Check Sum
0xAA	0xFF		0x03	'A'	0xE4	Status	

Status : Same as above

- **Nak**

Header	Command	ID	Data Length	Ack/Nak	r-CMD	Val 1	Check Sum
0xAA	0xFF		0x03	'N'	0xE4	ERR	

ERR : Error Code which is displayed when error is 300ccurred.

2.1.F9 Panel On/Off

- **Function**

Control the device panel mute mode

Note : Similar command is exist on 0x5a

- **Get**

Header	Command	ID	Data Length	Check Sum
0xAA	0xF9		0x00	

- **Set**

Header	Command	ID	Data Length	Data 1	Check Sum
0xAA	0xF9		0x01	PN_State	

PN_State : Panel ON/OFF code to be set on TV/Monitor

0x01	PANEL OFF	0x00	PANEL ON
------	-----------	------	----------

- **Ack**

Header	Command	ID	Data Length	Ack/Nak	r-CMD	Val 1	Check Sum
0xAA	0xFF		0x03	'A'	0xF9	PN_State	

PN_State : Same as above

- **Nak**

Header	Command	ID	Data Length	Ack/Nak	r-CMD	Val 1	Check Sum
0xAA	0xFF		0x03	'N'	0xF9	ERR	

ERR : Error code that shows what occurred error is

2.1.FD Auto ID Setting MDC Control Command

● Function

Communication data apth control for MDC auto ID functionality

● Get

Header	Command	ID	Data Length	Check Sum
0xAA	0xFD		0x00	

● Set

Header	Command	ID	Data Length	Data 1	Data 2	Check Sum
0xAA	0xFD		0x02	RS_Status	M_ID	

Note : If M_ID is 0, can't chage ID. (previous value.)

RS_Status : RS232 Output , ID information

Bit7	Bit6	Bit5	Bit4	Bit3	Bit2	Bit1	Bit0
0	0	0	1 or 0	0	0	0	1 or 0
1 : Initialize Monitor ID (Initialiize Monitor ID to 0) 0 : -				1 : RS232 Loop Out Disable 0 : RS232 Loop Out Enable			

Note : In Get Auto ID,can't know Monitor ID's reset status.

M_ID : ID

Bit7	Bit6	Bit5	Bit4	Bit3	Bit2	Bit1	Bit0
Change ID(1~253)							

Note : If Monitor ID reset bit of RS_Status is set, ignore M_ID
Depends on the product actual range can be differ

● Ack

Header	Command	ID	Data Length	Ack/Nak	r-CMD	Val 1	Val 2
0xAA	0xFF		0x04	'A'	0xFD	RS_Status	M_ID
Check Sum							

RS_Status, M_ID : Same as above

Note : Get cmd – In Ack, M_ID is current ID which is set.

● Nak

Header	Command	ID	Data Length	Ack/Nak	r-CMD	Val 1	Check Sum
0xAA	0xFF		0x03	'N'	0xFD	ERR	

ERR : Error Code which is displayed when error is 302ccurred.

- Ex) 1. All ID Reset : aa fd fe 02 10 00
 2. All Loopout disable : aa fd fe 02 01 00
 3. Set ID #1 : aa fd 00 02 01 01
 4. Enable ID #1 : aa fd 01 02 00 01

2.1.FE White Balance MDC Control

- **Function**

Control the white balance of the device.

- **Working Condition**

– Depends on each model spec it will be supported or not

- **Sub Command Table**

Sub CMD	Function	Sub CMD	Function
		0x62	White Balance Mode
0x81	Red Gain	–	–
0x91	Green Gain	–	–
0xA1	Blue Gain	–	–
0xB1	Red Offset	–	–
0xC1	Green Offset	–	–
0xD1	Blue Offset	–	–

Note : There specific working mode for white balance control, that is

- **Save White Balance Data From MagicNet**

Header	Command	ID	Data Length	r-CMD	Va1 1	Va1 2	Va1 3
0xAA	0xFE		0x0A	0x02	Source	Red Gain	Green Gain
Val 4	Val 5	Val 6	Val 7	Val 8	Val 9	Check Sum	
Blue Gain	Red Offset	Green Offset	Blue Offset	Sub Bright	Sub Contrast		

- **Ack[White Balance All Data]**

Header	Command	ID	Data Length	Ack/Nak	r-CMD	Val 1	Val 2
0xAA	0xFF		0x0B	'A'	0xFE	Current Source	Red Gain
Val 3	Val 4	Val 5	Val 6	Val 7	Val 8	Val 9	Check Sum
Green Gain	Blue Gain	Red Offset	Green Offset	Blue Offset	Sub Bright	Sub Contrast	

Current Source : Please refer Input table of Command 0x14, Input Source Control (MFM).

2.1.FE.62 White Balance Mode

- **Function**

Control the device white balance mode

- **Get**

Header	Command	ID	Data Length	Sub CMD	Check Sum
0xAA	0xFE		0x01	0x62	

- **Set**

Header	Command	ID	Data Length	Sub CMD	Data	Check Sum
0xAA	0xFE		0x02	0x62	White Balance Mode	

White Balance Mode :

0x00	Custom	0x01	Color Expert
------	--------	------	--------------

Note : Valuable red gain value range/default value can be differ by each product spec

- **Ack**

Header	Command	ID	Data Length	Ack/Nak	r-CMD	Val 1	Val 2
0xAA	0xFF		0x04	'A'	0xFE	0x62	White Balance Mode
Check Sum							

White Balance Mode : Same as above

- **Nak**

Header	Command	ID	Data Length	Ack/Nak	r-CMD	Val 1	Check Sum
0xAA	0xFF		0x03	'N'	0xFE	ERR	

ERR : Error Code which is displayed when error is occurred.

2.1.FE.81 Red Gain

- **Function**

Control the device white balance red gain value.

- **Get**

Header	Command	ID	Data Length	Sub CMD	Check Sum
0xAA	0xFE		0x01	0x81	

- **Set**

Header	Command	ID	Data Length	Sub CMD	Data	Check Sum
0xAA	0xFE		0x02	0x81	Red Gain	

Red Gain : Red gain value of the device

Note : Valuable red gain value range/default value can be differ by each product spec

- **Ack**

Header	Command	ID	Data Length	Ack/Nak	r-CMD	Val 1	Val 2
0xAA	0xFF		0x04	'A'	0xFE	0x81	Red Gain
Check Sum							

Red Gain : Same as above

- **Nak**

Header	Command	ID	Data Length	Ack/Nak	r-CMD	Val 1	Check Sum
0xAA	0xFF		0x03	'N'	0xFE	ERR	

ERR : Error Code which is displayed when error is occurred.

2.1.FE.91 Green Gain

- **Function**

Control the device white balance green gain value.

- **Get**

Header	Command	ID	Data Length	Sub CMD	Check Sum
0xAA	0xFE		0x01	0x91	

- **Set**

Header	Command	ID	Data Length	Sub CMD	Data	Check Sum
0xAA	0xFE		0x02	0x91	Green Gain	

Green Gain : Green gain value of the device

Note : Valuable red gain value range/default value can be differ by each product spec

- **Ack**

Header	Command	ID	Data Length	Ack/Nak	r-CMD	Val 1	Val 2
0xAA	0xFF		0x04	'A'	0xFE	0x91	Green Gain
Check Sum							

Green Gain : Same as above

- **Nak**

Header	Command	ID	Data Length	Ack/Nak	r-CMD	Val 1	Check Sum
0xAA	0xFF		0x03	'N'	0xFE	ERR	

ERR : Error Code which is displayed when error is occurred.

2.1.FE.A1 Blue Gain

- **Function**

Control the device white balance blue gain value.

- **Get**

Header	Command	ID	Data Length	Sub CMD	Check Sum
0xAA	0xFE		0x01	0xA1	

- **Set**

Header	Command	ID	Data Length	Sub CMD	Data	Check Sum
0xAA	0xFE		0x02	0xA1	Blue Gain	

Blue Gain : Blue gain value of the device

Note : Valuable red gain value range/default value can be differ by each product spec

- **Ack**

Header	Command	ID	Data Length	Ack/Nak	r-CMD	Val 1	Val 2
0xAA	0xFF		0x04	'A'	0xFE	0xA1	Blue Gain
Check Sum							

Blue Gain : Same as above

- **Nak**

Header	Command	ID	Data Length	Ack/Nak	r-CMD	Val 1	Check Sum
0xAA	0xFF		0x03	'N'	0xFE	ERR	

ERR : Error Code which is displayed when error is occurred.

2.1.FE.B1 Red Offset

- **Function**

Control the device white balance red offset value.

- **Get**

Header	Command	ID	Data Length	Sub CMD	Check Sum
0xAA	0xFE		0x01	0xB1	

- **Set**

Header	Command	ID	Data Length	Sub CMD	Data	Check Sum
0xAA	0xFE		0x02	0xB1	Red Offset	

Red Offset : Red offset value of the device

Note : Valuable red gain value range/default value can be differ by each product spec

- **Ack**

Header	Command	ID	Data Length	Ack/Nak	r-CMD	Val 1	Val 2
0xAA	0xFF		0x04	'A'	0xFE	0xB1	Red Offset
Check Sum							

Red Offset : Same as above

- **Nak**

Header	Command	ID	Data Length	Ack/Nak	r-CMD	Val 1	Check Sum
0xAA	0xFF		0x03	'N'	0xFE	ERR	

ERR : Error Code which is displayed when error is occurred.

2.1.FE.C1 Green Offset

- **Function**

Control the device white balance green offset value.

- **Get**

Header	Command	ID	Data Length	Sub CMD	Check Sum
0xAA	0xFE		0x01	0xC1	

- **Set**

Header	Command	ID	Data Length	Sub CMD	Data	Check Sum
0xAA	0xFE		0x02	0xC1	Green Offset	

Green Offset : Green offset value of the device

Note : Valuable red gain value range/default value can be differ by each product spec

- **Ack**

Header	Command	ID	Data Length	Ack/Nak	r-CMD	Val 1	Val 2
0xAA	0xFF		0x04	'A'	0xFE	0xC1	Green Offset
Check Sum							

Green Offset : Same as above

- **Nak**

Header	Command	ID	Data Length	Ack/Nak	r-CMD	Val 1	Check Sum
0xAA	0xFF		0x03	'N'	0xFE	ERR	

ERR : Error Code which is displayed when error is occurred.

2.1.FE.D1 Blue Offset

- **Function**

Control the device white balance blue offset value.

- **Get**

Header	Command	ID	Data Length	Sub CMD	Check Sum
0xAA	0xFE		0x01	0xD1	

- **Set**

Header	Command	ID	Data Length	Sub CMD	Data	Check Sum
0xAA	0xFE		0x02	0xD1	Blue Offset	

Blue Offset : Blue offset value of the device

Note : Valuable red gain value range/default value can be differ by each product spec

- **Ack**

Header	Command	ID	Data Length	Ack/Nak	r-CMD	Val 1	Val 2
0xAA	0xFF		0x04	'A'	0xFE	0xD1	Blue Offset
Check Sum							

Blue Offset : Same as above

- **Nak**

Header	Command	ID	Data Length	Ack/Nak	r-CMD	Val 1	Check Sum
0xAA	0xFF		0x03	'N'	0xFE	ERR	

ERR : Error Code which is displayed when error is occurred.

2.1.FF ACK/NAK

- **Function**

Acknowledge or Negative acknowledge packet for other command

Note : Daetail format is defined on ezch command

Annex A. Model dependency

A.1 PIC_MODE definition

- **A model which is support **** Text , **** Video/Image and Calibration as picture mode on the menu**
 1. If the picture mode on the menu is calibration, it will be treat as PIC_MODE_CALIB
In case of picture mode in the menu is not calibration
 2. If current source is AV, TV or Component
then the picture mode is treat as PIC_MODE_VIDEO regardless picture mode on the menu
 3. If current source is PC
then the picture mode is treat as PIC_MODE_PC regardless picture mode on the menu
 4. if current source is others(not listed in 2 or 3)
then it will be treat as PIC_MODE_VIDEO when the picture mode in the menu is *** Video/Image
or treat as PIC_MODE_PC when the picture mode in the menu is *** Text.

A.2 H-Position Control

- **Function**

Personal Computer adjusts Horizontal Position of Device.

- **Working Condition**

- PC(D-Sub), BNC Only
- When Video Wall is on or Zoom (0x39) is set, you can not control
- HKIA support option is on

- **Get H-Position Status**

Header	Command	ID	Data Length	Check Sum
0xAA	0x31		0x00	

- **Set H-Position**

Header	Command	ID	Data Length	Data 1	Check Sum
0xAA	0x31		0x01	H-Pos	

H-Pos : Value of 0 ~ 100

0	leftside max position
1 ~ 49	percentage position between leftside max ~ default
50	default position
51 ~ 99	percentage position between default ~ rightside max
100	rightside max position

- **Ack**

Header	Command	ID	Data Length	Ack/Nak	r-CMD	Val 1	Check Sum
0xAA	0xFF		0x03	'A'	0x31	H-Pos	

H-Pos : Same as above

- **Nak**

Header	Command	ID	Data Length	Ack/Nak	r-CMD	Val 1	Check Sum
0xAA	0xFF		0x03	'N'	0x31	ERR	

ERR : Error code that shows what occurred error is

A.3 V-Position Control

- **Function**

Personal Computer adjusts Vertical Position of TV/Monitor.

- **Working Condition**

- PC(D-Sub), BNC Only
- When Video Wall is on or Zoom (0x39) is set, you can not control
- HKIA support option is on

- **Get V-Position Status**

Header	Command	ID	Data Length	Check Sum
0xAA	0x32		0x00	

- **Set V-Position**

Header	Command	ID	Data Length	Data 1	Check Sum
0xAA	0x32		0x01	V-Pos	

V-Pos : Value of 0 ~ 100

0	upside max position
1 ~ 49	percentage position between upside max ~ default
50	default position
51 ~ 99	percentage position between default ~ downside max
100	downside max position

- **Ack**

Header	Command	ID	Data Length	Ack/Nak	r-CMD	Val 1	Check Sum
0xAA	0xFF		0x03	'A'	0x32	V-Pos	

V-Pos : Same as above

- **Nak**

Header	Command	ID	Data Length	Ack/Nak	r-CMD	Val 1	Check Sum
0xAA	0xFF		0x03	'N'	0x32	ERR	

ERR : Error code that shows what occurred error is

Annex B. Test Pattern

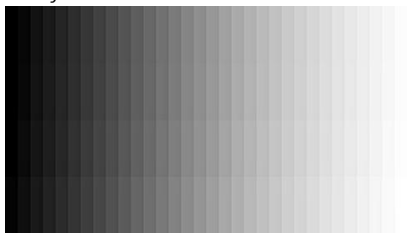
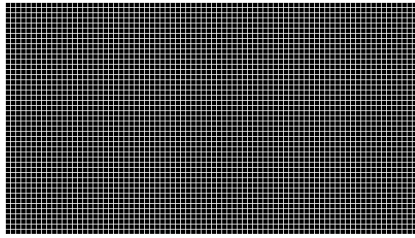
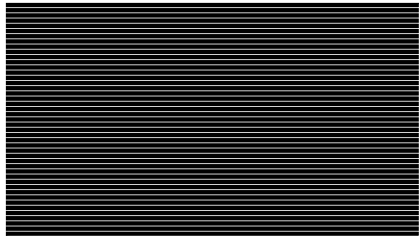
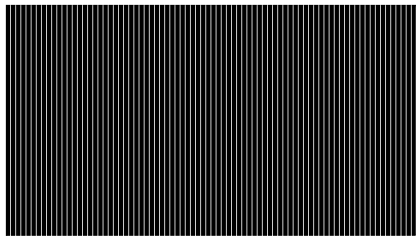
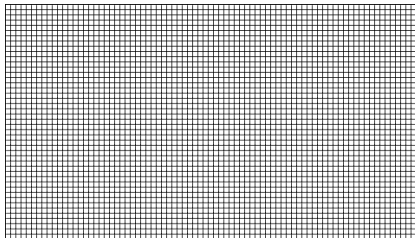
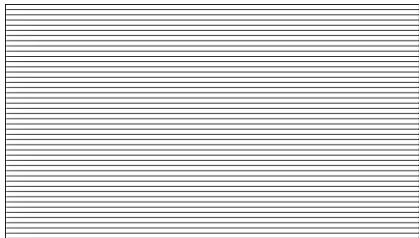
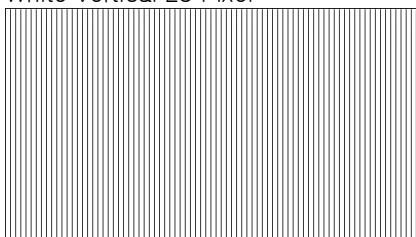
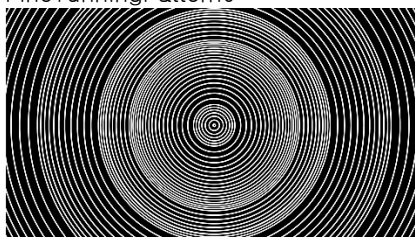
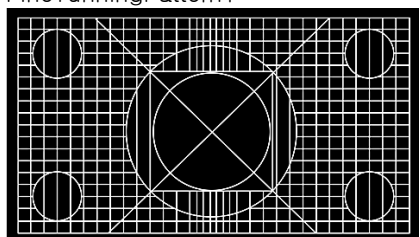
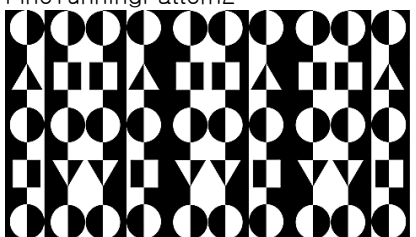
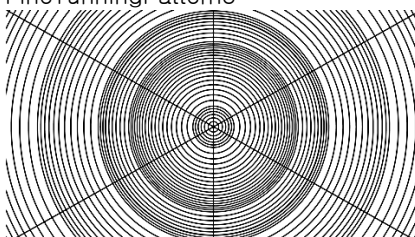
<p>Gray Scale</p> 	<p>Black Grid 25 Pixel</p> 	<p>Black Horizontal 25 Pixel</p> 
<p>Black Vertical 25 Pixel</p> 	<p>White Grid 25 Pixel</p> 	<p>White Horizontal 25 Pixel</p> 
<p>White Vertical 25 Pixel</p> 	<p>FineTunningPattern0</p> 	<p>FineTunningPattern1</p> 
<p>FineTunningPattern2</p> 	<p>FineTunningPattern3</p> 	<p>FineTunningPattern4</p> 